





**BUREAU
VERITAS**

Test Report No.: LD190808N030



Test Report No.: LD190808N030	
Client	
Name :	Shenzhen SOFAR SOLAR Co., Ltd.
Address :	401, Building 4, AnTongDa Industrial Park, District 68, XingDong Community, XinAn Street, BaoAn District, Shenzhen, China.
Test Item :	Hybrid inverter
Identification :	HYD 6000-ES, HYD 5000-ES, HYD 4600-ES, HYD 4000-ES, HYD 3600-ES, HYD 3000-ES
Issued by	
Name :	Bureau Veritas Shenzhen Co., Ltd. Dongguan Branch
Address :	No. 34, Chenwulu Section, Guantai Rd., Houjie Town, Dongguan City, Guangdong 523942, China
Test specification	
Standard :	IEC/EN 62109-1:2010, IEC/EN 62109-2:2011
Test Result :	The sample satisfies to the clauses examined.
CPrepared By :	
	
2019-08-15	
Date	
_____ Dora Zhang Project Engineer / Safety Department	
Approved By:	
	
2019-08-15	
Date	
_____ James Huang Technical Manger / Safety Department	
<p><small>This report is governed by, and incorporates by reference, CPS Conditions of Service as posted at the date of issuance of this report at http://www.bureauveritas.com/home/about-us/our-business/cps/about-us/terms-conditions/ and is intended for your exclusive use. Any copying or replication of this report to or for any other person or entity, or use of our name or trademark, is permitted only with our prior written permission. This report sets forth our findings solely with respect to the test samples identified herein. The results set forth in this report are not indicative or representative of the quality or characteristics of the lot from which a test sample was taken or any similar or identical product unless specifically and expressly noted. Our report includes all of the tests requested by you and the results thereof based upon the information that you provided to us. Measurement uncertainty is only provided upon request for accredited tests. You have 60 days from date of issuance of this report to notify us of any material error or omission caused by our negligence or if you require measurement uncertainty; provided, however, that such notice shall be in writing and shall specifically address the issue you wish to raise. A failure to raise such issue within the prescribed time shall constitute your unqualified acceptance of the completeness of this report, the tests conducted and the correctness of the report contents.</small></p>	



TEST REPORT	
IEC/EN 62109-1:2010, IEC/EN 62109-2:2011	
Safety of power converters for use in photovoltaic power systems –	
Part 1: General requirements	
Part 2: Particular requirements for inverters	
Report Number :	LD190808N030
Date of issue :	2019-08-15
Total number of pages	121
Testing laboratory	
Test location :	Bureau Veritas Shenzhen Co., Ltd. Dongguan Branch
Address :	No. 34, Chenwulu Section, Guantai Rd., Houjie Town, Dongguan City, Guangdong 523942, China
Applicant's name	Shenzhen SOFAR SOLAR Co., Ltd.
Address :	401, Building 4, AnTongDa Industrial Park, District 68, XingDong Community, XinAn Street, BaoAn District, Shenzhen, China.
Test specification:	
Standard :	IEC/EN 62109-1:2010 IEC/EN 62109-2:2011
Non-standard test method:	N/A
Test Report Form No.	TEST REPORT IEC 62109-2 VER.5
Test Report Form(s) Originator :	Bureau Veritas Shenzhen Co., Ltd. Dongguan Branch
Master TRF	Dated 2016-08
Test item description :	Hybrid inverter
Trade Mark :	
Manufacturer	Shenzhen SOFAR SOLAR Co., Ltd.
Model/Type reference :	HYD 6000-ES, HYD 5000-ES, HYD 4600-ES, HYD 4000-ES, HYD 3600-ES, HYD 3000-ES



Ratings :	HYD 6000-ES	HYD 5000-ES	HYD 4600-ES
Full load MPP DC voltage range [V] :	300-520	250-520	230-520
Input DC voltage range[V]..... :	90 - 580		
Input DC current [A] :	Max. 12.0 x 2		
Output AC voltage [V] :	230, 50Hz		
Output AC current [A]..... :	Max. 27.3	Max.22.8	Max.21.0
Output power [VA]..... :	6000	5000	4600
Output DC voltage range [V]..... : [Battery charge]..... :	42-58Vdc		
Input DC current [A] : [Battery charge]..... :	Max.65A		
Output DC current [A] : [Battery discharge]..... :	Max. 70A		
Charge and discharge power[VA].... :	Max. 3000		
Output AC voltage [V] :	230Vac, 50Hz		
Output AC current [A]..... :	Max.13.2		
Output power [VA]..... :	3000		

Ratings :	HYD 4000-ES	HYD 3600-ES	HYD 3000-ES
Full load MPP DC voltage range [V] :	200-520	180-520	160-520
Input DC voltage range[V]..... :	90 - 580		
Input DC current [A] :	Max. 12.0 x 2		
Output AC voltage [V] :	230, 50Hz		
Output AC current [A]..... :	Max.18.2	Max.16.0	Max. 13.7
Output power [VA]..... :	4000	3680	3000
Output DC voltage range [V]..... : [Battery charge]..... :	42-58Vdc		
Input DC current [A] : [Battery charge]..... :	Max.65A		
Output DC current [A]..... : [Battery discharge]..... :	Max. 70A		
Charge and discharge power[VA].... :	Max. 3000		
Output AC voltage [V] :	230Vac, 50Hz		
Output AC current [A]..... :	Max.13.2		
Output power [VA]..... :	3000		



Copy of marking plate (representative)

SOFAR SOLAR
Hybrid Inverter

Model No: HYD 6000-ES

Max.DC Input Voltage	600V
Operating MPPT Voltage Range	90V~580V
MAX.PV Isc	2x15A
Battery Type	Lead-acid,Lithium-ion
Battery Voltage Range	42-58V
Max.Charging Current	65A
Max.Discharging Current	70A
Max.Charging&Discharging Power	3000VA
Nominal Grid Voltage	230Vac
Nominal Output Voltage	230Vac
Max.Output Current	27.3A
Nominal Grid Frequency	50/60Hz
Power Factor	1(adjustable+/-0.8)
Nominal Output Power	6000VA
Backup Rated Current	13.2A
Backup Rated Apparent Power	3000VA
Ingress Protection	IP65
Operating Temperature Range	-25~+60°C
Protective Class	Class I

Manufacturer : Shenzhen SOFAR SOLAR Co.,Ltd.
Address : 401, Building 4, An TongDa Industrial Park,
District 68, XingDong Community,XinAn Street,
BaoAn District, Shenzhen, China
SAA183423
VDE0126-1-1,VDE-AR-N4105,G99,EN50438,
AS4777,UTE C15-712-1

SOFAR SOLAR
Hybrid Inverter

Model No: HYD 5000-ES

Max.DC Input Voltage	600V
Operating MPPT Voltage Range	90V~580V
MAX.PV Isc	2x15A
Battery Type	Lead-acid,Lithium-ion
Battery Voltage Range	42-58V
Max.Charging Current	65A
Max.Discharging Current	70A
Max.Charging&Discharging Power	3000VA
Nominal Grid Voltage	230Vac
Nominal Output Voltage	230Vac
Max.Output Current	22.8A
Nominal Grid Frequency	50/60Hz
Power Factor	1(adjustable+/-0.8)
Nominal Output Power	5000VA
Backup Rated Current	13.2A
Backup Rated Apparent Power	3000VA
Ingress Protection	IP65
Operating Temperature Range	-25~+60°C
Protective Class	Class I

Manufacturer : Shenzhen SOFAR SOLAR Co.,Ltd.
Address : 401, Building 4, An TongDa Industrial Park,
District 68, XingDong Community,XinAn Street,
BaoAn District, Shenzhen, China
SAA183423
VDE0126-1-1,VDE-AR-N4105,G99,EN50438,
AS4777,UTE C15-712-1

SOFAR SOLAR
Hybrid Inverter

Model No: HYD 4600-ES

Max.DC Input Voltage	600V
Operating MPPT Voltage Range	90V~580V
MAX.PV Isc	2x15A
Battery Type	Lead-acid,Lithium-ion
Battery Voltage Range	42-58V
Max.Charging Current	65A
Max.Discharging Current	70A
Max.Charging&Discharging Power	3000VA
Nominal Grid Voltage	230Vac
Nominal Output Voltage	230Vac
Max.Output Current	21.0A
Max.Short Current	21.0A
Z _{source}	1.05 + j0.32 ohm
Nominal Grid Frequency	50/60Hz
Power Factor	1(adjustable+/-0.8)
Nominal Output Power	4600VA
Backup Rated Current	13.2A
Backup Rated Apparent Power	3000VA
Ingress Protection	IP65
Operating Temperature Range	-25~+60°C
Protective Class	Class I

Manufacturer : Shenzhen SOFAR SOLAR Co.,Ltd.
Address : 401, Building 4, An TongDa Industrial Park,
District 68, XingDong Community,XinAn Street,
BaoAn District, Shenzhen, China
SAA183423
VDE0126-1-1,VDE-AR-N4105,G99,EN50438,
AS4777,UTE C15-712-1

SOFAR SOLAR
Hybrid Inverter

Model No: HYD 4000-ES

Max.DC Input Voltage	600V
Operating MPPT Voltage Range	90V~580V
MAX.PV Isc	2x15A
Battery Type	Lead-acid,Lithium-ion
Battery Voltage Range	42-58V
Max.Charging Current	65A
Max.Discharging Current	70A
Max.Charging&Discharging Power	3000VA
Nominal Grid Voltage	230Vac
Nominal Output Voltage	230Vac
Max.Output Current	18.2A
Nominal Grid Frequency	50/60Hz
Power Factor	1(adjustable+/-0.8)
Nominal Output Power	4000VA
Backup Rated Current	13.2A
Backup Rated Apparent Power	3000VA
Ingress Protection	IP65
Operating Temperature Range	-25~+60°C
Protective Class	Class I

Manufacturer : Shenzhen SOFAR SOLAR Co.,Ltd.
Address : 401, Building 4, An TongDa Industrial Park,
District 68, XingDong Community,XinAn Street,
BaoAn District, Shenzhen, China
SAA183423
VDE0126-1-1,VDE-AR-N4105,G99,EN50438,
AS4777,UTE C15-712-1



Model No: HYD 3600-ES

Max.DC Input Voltage	600V
Operating MPPT Voltage Range	90V~580V
MAX.PV Isc	2x15A
Battery Type	Lead-acid,Lithium-ion
Battery Voltage Range	42-58V
Max.Charging Current	65A
Max.Discharging Current	70A
Max.Charging&Discharging Power	3000VA
Nominal Grid Voltage	230Vac
Nominal Output Voltage	230Vac
Max.Output Current	16A
Nominal Grid Frequency	50/60Hz
Power Factor	1(adjustable+/-0.8)
Nominal Output Power	3680VA
Backup Rated Current	13.2A
Backup Rated Apparent Power	3000VA
Ingress Protection	IP65
Operating Temperature Range	-25~+60°C
Protective Class	Class I

Manufacturer : Shenzhen SOFAR SOLAR Co.,Ltd.
 Address : 401, Building 4, An TongDa Industrial Park,
 District 88, XingDong Community,XinAn Street,
 BaoAn District, Shenzhen, China
 SAA183423
 VDE0126-1-1,VDE-AR-N4105,G98,EN50438,
 AS4777,UTE C15-712-1



Model No: HYD 3000-ES

Max.DC Input Voltage	600V
Operating MPPT Voltage Range	90V~580V
MAX.PV Isc	2x15A
Battery Type	Lead-acid,Lithium-ion
Battery Voltage Range	42-58V
Max.Charging Current	65A
Max.Discharging Current	70A
Max.Charging&Discharging Power	3000VA
Nominal Grid Voltage	230Vac
Nominal Output Voltage	230Vac
Max.Output Current	13.7A
Nominal Grid Frequency	50/60Hz
Power Factor	1(adjustable+/-0.8)
Nominal Output Power	3000VA
Backup Rated Current	13.2A
Backup Rated Apparent Power	3000VA
Ingress Protection	IP65
Operating Temperature Range	-25~+60°C
Protective Class	Class I

Manufacturer : Shenzhen SOFAR SOLAR Co.,Ltd.
 Address : 401, Building 4, An TongDa Industrial Park,
 District 88, XingDong Community,XinAn Street,
 BaoAn District, Shenzhen, China
 SAA183423
 VDE0126-1-1,VDE-AR-N4105,G98,EN50438,
 AS4777,UTE C15-712-1





Test item particulars:	
Equipment mobility.....:	<input type="checkbox"/> movable <input type="checkbox"/> hand-held <input type="checkbox"/> stationary <input checked="" type="checkbox"/> fixed <input type="checkbox"/> transportable <input type="checkbox"/> for building-in
Connection to the mains.....:	<input type="checkbox"/> pluggable equipment <input type="checkbox"/> direct plug-in <input checked="" type="checkbox"/> permanent connection <input type="checkbox"/> for building-in
Environmental category.....:	<input type="checkbox"/> outdoor <input type="checkbox"/> indoor unconditional <input checked="" type="checkbox"/> indoor conditional
Over voltage category Mains.....:	<input type="checkbox"/> OVC I <input type="checkbox"/> OVC II <input checked="" type="checkbox"/> OVC III <input type="checkbox"/> OVC IV
Over voltage category DC.....:	<input type="checkbox"/> OVC I <input checked="" type="checkbox"/> OVC II <input type="checkbox"/> OVC III <input type="checkbox"/> OVC IV
Mains supply tolerance (%).....:	-90 / +110 %
Tested for power systems.....:	TN
IT testing, phase-phase voltage (V).....:	---
Class of equipment.....:	<input checked="" type="checkbox"/> Class I <input type="checkbox"/> Class II <input type="checkbox"/> Class III <input type="checkbox"/> Not classified
Mass of equipment (kg).....:	Approx. 20.5
Pollution degree.....:	PD2(Reduction of table 5 is considered)
IP protection class.....:	IP65
.....:	
Testing	
Date of receipt of test item(s).....:	2018-09-03 & 2019-08-08
Dates tests performed.....:	2018-09-03 to 2018-12-03 & 2019-08-08 to 2019-08-10
Possible test case verdicts:	
- test case does not apply to the test object.....:	N/A
- test object does meet the requirement.....:	Pass (P)
- test object was not evaluated for the requirement:	N/E
- test object does not meet the requirement.....:	Fail (F)



General remarks:

The test results presented in this report relate only to the object tested.
This report shall not be reproduced, except in full, without the written approval of the Issuing testing laboratory.

"(See Enclosure #)" refers to additional information appended to the report.

"(See appended table)" refers to a table appended to the report.

Report history:

Remark 1	This test report is to replace the original test report LD180903N042-R1. issue by Bureau Veritas Shenzhen Co., Ltd. Dongguan Branch, on 04, Feb., 2018.
Remark 2	The modification applied on this report is: <ul style="list-style-type: none"> - Add new model HYD 4600-ES. - Change all the lables: the product parameters has not changed. - Change the applicant's address.
Remark 3	For the above "Remark 2" described changes, clause 4.2.2.6 mains supply electrical data in normal condition were considered necessary.

Throughout this report a comma / point is used as the decimal separator.

Name and address of factory (ies).....:	Dongguan SOFAR SOLAR Co.,Ltd.
	1F - 6F, Building E, No. 1 JinQi Road, Bihu Industrial Park, Wulian Village, Fenggang Town, Dongguan City

General product information:

The Hybrid inverter is a single-phase type and only one machine is allowed on each line conductor. The input and output are protected by varistors to Earth. The unit is providing EMC filtering at the PV input and output toward mains. The unit does not provide galvanic separation from input to output (transformerless). The output is switched off redundantly by the high power switching bridge and two relays. This assures that the opening of the output circuit will also operate in case of a single error.

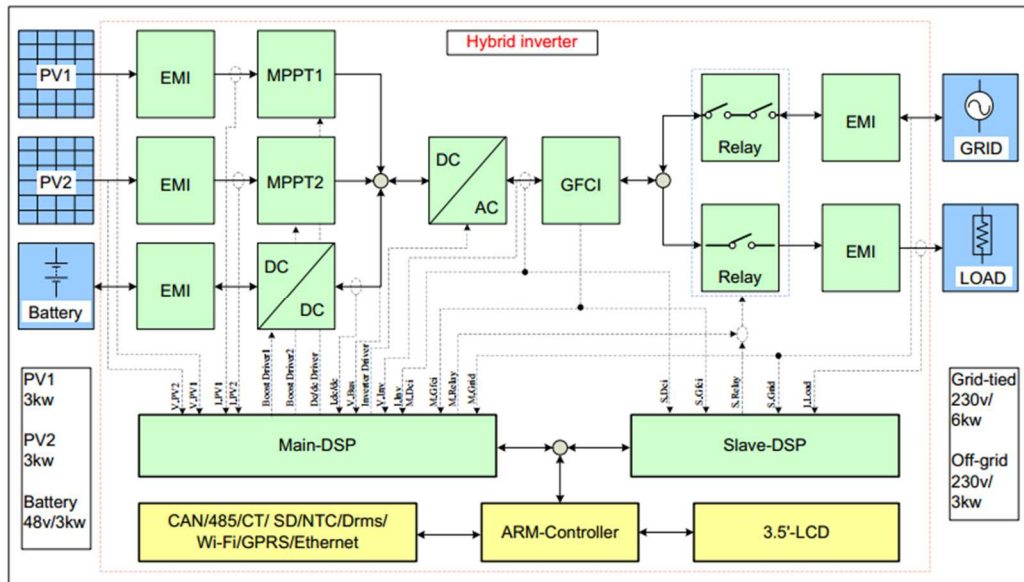

Figure 1 – Block diagram

The internal control is redundant built. It consists of Microcontroller Main DSP (U4) and slave DSP (U22).

The Main DSP (U4) control the relays by switching signals; measures the PV voltage, PV current, Bus voltage, grid voltage, frequency, AC current with injected DC and the array insulation resistance to ground. In addition it tests the current sensors and the RCMU circuit before each start up.

The slave DSP (U22) is measures the grid voltage, grid frequency and residual current, also can switch off the relays independently, and communicate with Main DSP (U4) each other.

The current is measured by a current sensor. The AC current signal and the injected DC current signal are sent to the Main DSP(U4). The Main DSP(U4) tests and calibrates before each start up all current sensors. The unit provides two relays in series in all output conductors. When single fault applied to one relay, alarm an error code in display panel, another redundant relay provides basic insulation maintained between the PV array and the mains. All the relays are tested before each start up.

The models HYD 3000-ES, HYD 3600-ES, HYD 4000-ES, HYD 4600-ES ,HYD 5000-ES and HYD 6000-ES are completely identical and output power derated by software, except for the following table.



Modle	HYD 6000-ES	HYD 5000-ES	HYD 4600-ES	HYD 4000-ES	HYD 3600-ES	HYD 3000-ES
Resistance (R332,R334,R336,R338)	(0Ω, NC, 0Ω,0Ω)			(NC, 0Ω, NC, 0Ω)		
Bus capacitance	8 pcs			6pcs		
INV inductor (R190)	0.75mH			1.035mH		
(R123,R132)	30kΩ			40.2kΩ		
	(1.5kΩ, 1.5kΩ)			(499Ω, 499Ω)		

The product was tested on:

Hardware version: V1.0
Software version: V1.00

Test condition:

Temperature: 20±5°C
Relative humidity: 60%
Air pressure: 950 mbar

The test samples were pre-production samples without serial number.



This testreport includes the following Appendixes:

Appendix No.	Description	Page(s)
1	4.8.2 TABLE: Array insulation resistance detection for inverters for ungrounded and functionally grounded arrays (page 106).	1
2	4.8.3.5 Protection by residual current monitoring (page 107-108).	2



IEC/EN 62109-1, IEC/EN 62109-2			
Clause	Requirement – Test	Result – Remark	Verdict
4	GENERAL TESTING REQUIREMENTS		P
4.1	General		P
4.2	General conditions for testing	See appended table.	P
4.3	Thermal testing	See appended table.	P
4.3.1	General		P
4.3.2	Maximum temperatures	See appended table.	P
4.3.2.1	General		P
4.3.2.2	Touch temperatures		P
	In order to limit the touch temperatures of accessible parts of PCE, the maximum temperature for accessible parts of the PCE shall be in compliance with Table 3.	Considered.	P
	It is permitted that accessible parts that are required to get hot as part of their intended function (for example heatsinks) may have temperatures up to 100 °C, if the parts are marked with the hot surface marking of symbol 14 of Annex C. For products only for use in a closed electrical operating area the 100 °C limit does not apply.	Considered.	P
	These limits are in addition to the applicable limits in 4.3.2.1.	Considered.	P
4.3.2.3	Temperature limits for mounting surfaces		P
	In order to protect against long-term degradation of building materials, surfaces of the PCE that will be in contact with the mounting surface shall not exceed a maximum total temperature of 90 °C. This limit is in addition to the applicable limits in 4.3.2.1 and 4.3.2.2. Compliance is checked by the testing in 4.3.2.1 with the PCE mounted according to the manufacturer's instructions, on a softwood surface.	Considered.	P
4.4	Testing in single fault condition	See appended table.	P
4.4.1	General		P
4.4.2	Test conditions and duration for testing under fault conditions	Considered.	P
4.4.2.1	General		P
4.4.2.2	Duration of tests	Considered.	P
4.4.3	Pass/fail criteria for testing under fault conditions		P
4.4.3.1	Protection against shock hazard	No shock hazard.	P
4.4.3.2	Protection against the spread of fire	No spread of fire.	P
4.4.3.3	Protection against other hazards	No other hazards.	P
4.4.3.4	Protection against parts expulsion hazards	No expulsion hazard.	P
4.4.4	Single fault conditions to be applied	Considered.	P
4.4.4.1	Component fault tests	See appended table.	P
4.4.4.2	Equipment or parts for short-term or intermittent operation	Continue-operation.	N/A
	Components such as motors, relays, other electromagnetic devices and heaters, which are normally operated only intermittently, shall be operated continuously if continuous operation could occur in a single fault condition.		N/A
4.4.4.3	Motors		P
4.4.4.4	Transformer short circuit tests	See appended table.	P



IEC/EN 62109-1, IEC/EN 62109-2			
Clause	Requirement – Test	Result – Remark	Verdict
4.4.4.5	Output short circuit	See appended table.	P
4.4.4.6	Backfeed current test for equipment with more than one source of supply	Considered.	P
	For equipment intended to be connected simultaneously to more than one source of supply, each input of the PCE shall be tested one at a time, to determine if hazardous conditions can result from current from one source of supply flowing into the wiring for another source under fault conditions.	Considered.	P
	With the PCE operating under normal conditions, a short circuit shall be applied at the field wiring terminals of the circuit under consideration, with all intended other sources connected to the PCE through the overcurrent protective devices (if any) intended to be present in the installation.	Considered.	P
	In addition to the requirements of 4.4.3, the short-circuit currents are to be recorded and if they exceed the maximum rated current for the port, the maximum measured current shall be provided in the installation manual for the purpose of coordination of overcurrent protection of the external circuit conductors (see 5.3.2).		N/A
4.4.4.7	Output overload	Considered.	P
4.4.4.8	Cooling system failure		P
	Equipment cooling shall be faulted as follows, one fault at a time:	See below.	P
	a) air-intakes shall be blocked or partially blocked;	Considered.	P
	b) cooling fans shall be stopped or disconnected, one at a time;	Considered.	P
	c) cooling by circulation of water or other coolant shall be stopped or partially restricted.	No such coolant circulation devices.	N/A
4.4.4.9	Heating devices	No heating devices.	N/A
	In equipment incorporating heating devices, the following faults shall be applied one at a time:		N/A
	a) timers which limit the heating period shall be overridden to energize the heating circuit continuously;		N/A
	b) temperature control devices or circuits shall have single fault conditions applied such that control over the heater is lost. Over-temperature protection devices meeting the requirements of 14.3 are left operational during the test.		N/A
4.4.4.10	Safety interlock systems	No such systems.	N/A
4.4.4.11	Reverse d.c. connections	Considered.	P
	Unless the means of connection prevents reversal, external d.c. connections shall be connected with reverse polarity.		N/A
4.4.4.12	Voltage selector mismatch	No such devices.	N/A
	Equipment employing a voltage selector intended to be adjusted or set to match the supply voltage, is to have its voltage selector set in any position with the equipment connected to any of its rated supply circuits.		N/A



IEC/EN 62109-1, IEC/EN 62109-2			
Clause	Requirement – Test	Result – Remark	Verdict
4.4.4.13	Mis-wiring with incorrect phase sequence or polarity	No any hazard occurred.	P
	If connection to the a.c. supply with incorrect phase sequence or incorrect polarity of an earthed single-phase supply could result in a hazard, a mis-wiring test shall be applied.		P
4.4.4.14	Printed wiring board short-circuit test	See appended table.	P
	Where permitted by 7.3.7.7, functional insulation on PWBs, provided by spacings that are less than those specified in Table 7 and Table 8 (see 7.3.7.7) shall be type tested as described below.		P
	Each location of decreased spacings shall be short-circuited one at a time, and the shortcircuit shall be maintained until no further damage occurs. Overcurrent protection integral to the PCE, or required to be used with the PCE, is allowed to open. During and after each test, the PCE shall comply with the requirements of 4.4.3.		P
4.4.4.15 of IEC 62109-2	Fault-tolerance of protection for grid-interactive inverters	See below.	P
4.4.4.15.1 of IEC 62109-2	Fault-tolerance of residual current monitoring according to 4.8.3.5: the residual current monitoring system operates properly	See appended table.	P
	a) .- The inverter ceases to operate	See appended table.	P
	- Indicates a fault in accordance with §13.9		P
	- Disconnect from the mains		P
	- not re-connect after any sequence of removing and reconnecting PV power		P
	- not re-connect after any sequence of removing and reconnecting AC power		P
	- not re-connect after any sequence of removing and reconnecting both PV and AC power		P
	b) .- The inverter continues to operate	The inverter ceases to operate.	N/A
	- the residual current monitoring system operates properly under single fault condition		N/A
	- Indicates a fault in accordance with §13.9		N/A
	c)..- The inverter continues to operate regardless of loss of residual current monitoring functionality		N/A
	- not re-connect after any sequence of removing and reconnecting PV power		N/A
	- not re-connect after any sequence of removing and reconnecting AC power		N/A
	- not re-connect after any sequence of removing and reconnecting both PV and AC power		N/A
	- Indicates a fault in accordance with §13.9		N/A
4.4.4.15.2 of IEC 62109-2	Fault-tolerance of automatic disconnecting means	Two series relay in each line and may independent operation for each relay.	P



IEC/EN 62109-1, IEC/EN 62109-2			
Clause	Requirement – Test	Result – Remark	Verdict
4.4.4.15.2.1 of IEC 62109-2	General		P
	The means provided for automatic disconnection of a grid-interactive inverter from the mains shall:		P
	- disconnect all grounded current-carrying conductors from the mains	Disconnected all line conductors from the mains.	P
	- disconnect all ungrounded current-carrying conductors from the mains		P
	- be such that with a single fault applied to the disconnection means or to any other location in the inverter, at least basic insulation or simple separation is maintained between the PV array and the mains when the disconnecting means is intended to be in the open state.	The least basic insulation is maintained between the PV array, battery and the mains when the relay on the open state.	P
4.4.4.15.2.2 of IEC 62109-2	Design of insulation or separation complies with requirements of 7.3.7 of Part 1: report here Part 1 comment and verdict.	Considered.	P
4.4.4.15.2.3 of IEC 62109-2	For non-isolated inverter, automatic checking of the isolation provided by a disconnect means after singlefault.	The inverter automatic checking of the isolation after single fault occurred.	P
	If the check fail:		P
	- any still-functional disconnection means shall be left in the open position		P
	- at least basic or simple separation shall be maintained between the PV input and the mains		P
	- the inverter shall not start operation		P
	- the inverter shall indicate a fault in accordance with 13.9	The screen shown error information.	P
4.4.4.16 of IEC 62109-2	A stand-alone inverter with a transfer switch to transfer AC loads from the mains or other AC bypass source to the inverter output:	No such transfer switch	N/A
	- shall continue to operate normally		N/A
	- shall not present a risk of fire as the result of an out-of-phase transfer		N/A
	- shall not present a risk of shock as the result of an out-of-phase transfer		N/A
	- And having control preventing switching: components for malfunctioning		N/A
4.4.4.17 of IEC 62109-2	Cooling system failure – Blanketing test No hazards according to the criteria of sub-clause 4.4.3 of Part 1 shall result from blanketing the inverter This test is not required for inverters restricted to use only in closed electrical operating areas.	See appended table.	P
	Test stop condition: time duration value or stabilized temperature	Considered.	P
4.5	Humidity preconditioning		P
4.5.1	General		P
4.5.2	Conditions		P
4.6	Backfeed voltage protection	Considered.	P
4.6.1	Backfeed tests under normal conditions		P



IEC/EN 62109-1, IEC/EN 62109-2			
Clause	Requirement – Test	Result – Remark	Verdict
	Each input source shall be tested separately by first disconnecting the source and then by deenergizing the source (if possible).		P
4.6.2	Backfeed tests under single-fault conditions	Considered.	P
	The tests in 4.6.1 are repeated for each single fault condition under consideration. Faults to be applied are selected based on analysis of schematics of the circuitry with particular attention to devices that control or transfer energy between different sources.		P
4.6.3	Compliance with backfeed tests	Considered.	P
	The PCE is compliant with the requirements if during the tests in 4.6.1 and 4.6.2 no hazardous voltage or energy is present on the PCE terminals for the source under test. Measurements are taken 15 s or 1 s after the source is de-energized or disconnected, as follows:		P
	– 15 s for sources that are permanently connected;		P
	– 1 s for sources that are cord-connected or use connectors that can be opened without the use of a tool.	Permanently connected.	N/A
4.7	Electrical ratings tests	See appended table.	P
4.7.1	Input ratings	See appended table.	P
	While operating under the reference test conditions of 4.2.2, the measured continuous input current or power, as applicable, shall not exceed the marked input ratings by more than 10 %.	See appended table.	P
4.7.1.1	Measurement requirements for DC input ports		P
4.7.2	Output ratings		P
	While operating under the reference test conditions of 4.2.2, each output port of the PCE shall be capable of providing its marked output power or current ratings, as applicable, without overcurrent protective devices operating and without shutdown due to operation of overtemperature protection systems. The measured continuous output current or power, as applicable, shall not exceed the marked output ratings by more than 10 %.	Considered.	P
4.7.3 of IEC 62109-2	Measurement requirements for AC output ports for stand-alone inverters		P
4.7.4 of IEC 62109-2	Stand-alone Inverter AC output voltage and frequency		P
4.7.4.1 of IEC 62109-2	General		P
4.7.4.2 of IEC 62109-2	Steady state output voltage at nominal DC input The steady-state AC output voltage shall not be less than 90 % or more than 110 % of the rated nominal voltage with the inverter supplied with its nominal value of DC input voltage.	See appended table.	P



IEC/EN 62109-1, IEC/EN 62109-2			
Clause	Requirement – Test	Result – Remark	Verdict
4.7.4.3 of IEC 62109-2	Steady state output voltage across the DC input range The steady-state AC output voltage shall not be less than 85 % or more than 110 % of the rated nominal voltage with the inverter supplied with any value within the rated range of DC input voltage.	See appended table.	P
4.7.4.4 of IEC 62109-2	Load step response of the output voltage at nominal DC input The AC output voltage shall not be less than 85 % or more than 110 % of the rated nominal voltage for more than 1,5 s after application or removal of a resistive load.	See appended table.	P
4.7.4.5 of IEC 62109-2	Steady state output frequency The steady-state AC output frequency shall not vary from the nominal value by more than +4 % or –6 %.	See appended table.	P
4.7.5 of IEC 62109-2	Stand-alone inverter output voltage waveform		P
4.7.5.1 of IEC 62109-2	General		P
4.7.5.2 of IEC 62109-2	The AC output voltage waveform of a sinusoidal output stand-alone inverter shall have a total harmonic distortion (THD) not exceeding of 10 % and no individual harmonic at a level exceeding 6 %.	See appended table.	P
4.7.5.3 of IEC 62109-2	Non-sinusoidal output waveform requirements		N/A
4.7.5.3.1 of IEC 62109-2	General		N/A
4.7.5.3.2 of IEC 62109-2	The total harmonic distortion (THD) of the voltage waveform shall not exceed 40 %.		N/A
4.7.5.3.3 of IEC 62109-2	The slope of the rising and falling edges of the positive and negative half-cycles of the voltage waveform shall not exceed 10 V/ μ s measured between the points at which the waveform has a voltage of 10 % and 90 % of the peak voltage for that half-cycle.		N/A
4.7.5.3.4 of IEC 62109-2	The absolute value of the peak voltage of the positive and negative half-cycles of the waveform shall not exceed 1,414 times 110 % of the RMS value of the rated nominal AC output voltage.		N/A
4.7.5.4 of IEC 62109-2	Information requirements for non-sinusoidal waveforms The instructions provided with a stand-alone inverter not complying with 4.7.5.2 shall include the information in 5.3.2.6.		N/A
4.7.5.5 of IEC 62109-2	Output voltage waveform requirements for inverters for dedicated loads		N/A



IEC/EN 62109-1, IEC/EN 62109-2			
Clause	Requirement – Test	Result – Remark	Verdict
	For an inverter that is intended only for use with a known dedicated load, the following requirements may be used as an alternative to the waveform requirements in 4.7.5.2 to 4.7.5.3.		N/A
	The combination of the inverter and dedicated load shall be evaluated to ensure that the output waveform does not cause any hazards in the load equipment and inverter, or cause the load equipment to fail to comply with the applicable product safety standards.	Grid-interactive inverter.	N/A
	The inverter shall be marked with symbols 9 and 15 of Table C.1 of Part 1.	Grid-interactive inverter.	N/A
	The installation instructions provided with the inverter shall include the information in 5.3.2.13.	Grid-interactive inverter.	N/A
4.8 of IEC 62109-2	Additional tests for grid-interactive inverters	Considered.	P
4.8.1 of IEC 62109-2	General requirements regarding inverter isolation and array grounding	Non-isolation inverter.	N/A
	- Type of Array grounding supported		N/A
	- Inverter isolation		N/A
4.8.2 of IEC 62109-2	Array insulation resistance detection for inverters for ungrounded and functionally grounded arrays	Inverter checks the array isolation resistance before start up.	P
4.8.2.1 of IEC 62109-2	Array insulation resistance detection for inverters for ungrounded arrays	Considered.	P
	Inverter shall have means to measure DC insulation resistance from PV input (array) to ground before starting operation	Considered.	P
	Or Inverter shall be provided with instruction in accordance with 5.3.2.11.		P
	Measured DC insulation resistance:	See appended table.	P
	Inverter measurement circuit shall be capable of detecting insulation resistance below the limit value $R = V_{max}/30mA$ under normal conditions	Considered.	P
	Inverter measurement circuit shall be capable of detecting insulation resistance below the limit value $R = V_{max}/30mA$ with ground fault in the PV array	Considered.	P
	Isolated inverters shall indicate a fault if the insulation resistance is less than the limit value	The product is a non-isolated inverter.	N/A
	Isolated inverter fault indication maintained until insulation resistance has recovered to a value higher than the limit value		P
	Non-isolated inverters, or inverters with isolation not complying with the leakage current limits in the minimum inverter isolation requirements in Table 30:		P
	- shall indicate a fault in accordance with 13.9	Screen shown the error information.	P
	- shall not connect to the mains	Relay keep up opened.	P
4.8.2.2 of IEC 62109-2	Array insulation resistance detection for inverters for functionally grounded arrays	Inverter did not intend connected functionally grounded arrays.	N/A



IEC/EN 62109-1, IEC/EN 62109-2			
Clause	Requirement – Test	Result – Remark	Verdict
	a-1) The value of the total resistance, including the intentional resistance for array functional grounding, the expected insulation resistance of the array to ground, and the resistance of any other networks connected to ground (for example measurement networks) must not be lower than $R = (V_{MAX} PV/30 \text{ mA})$ ohms.		N/A
	a-2) The installation instructions shall include the information required in 5.3.2.12.		N/A
	b-1) As an alternative to a), or if a resistor value lower than in a) is used, the inverter shall incorporate means to detect, during operation, if the total current through the resistor and any networks (for example measurement networks) in parallel with it, exceeds the residual current values and times in Table 31		N/A
	b-2) Inverter shall either disconnect the resistor or limit the current by other means		N/A
	b-3) If the inverter is a non-isolated inverter, or has isolation not complying with the leakage current limits in the minimum inverter isolation requirements in Table 30, it shall also disconnect from the mains.		N/A
	c) The inverter shall have means to measure the DC insulation resistance from the PV input to ground before starting operation, in accordance with 4.8.2.1.		N/A
4.8.3 of IEC 62109-2	Array residual current detection		P
4.8.3.1 of IEC 62109-2	General	See below.	P
4.8.3.2 of IEC 62109-2	30 mA touch current type test for isolated inverters	Non-isolated inverters.	N/A
4.8.3.3 of IEC 62109-2	Fire hazard residual current type test for isolated inverters	Non-isolated inverters.	N/A
4.8.3.4 of IEC 62109-2	Protection by application of RCD's	The PCE provides an integrated RCDs.	N/A
	- The requirement for additional protection in 4.8.3.1 can be met by provision of an RCD with a residual current setting of 30 mA, located between the inverter and the mains..		N/A
	- The selection of the RCD type to ensure compatibility with the inverter must be made according to rules for RCD selection in Part 1.		N/A
	- The RCD provided integral to the inverter, or		N/A
	- The RCD provided by the installer if details of the rating, type, and location for the RCD are given in the installation instructions per 5.3.2.9.		N/A
4.8.3.5 of IEC 62109-2	Protection by residual current monitoring	See below.	P



IEC/EN 62109-1, IEC/EN 62109-2			
Clause	Requirement – Test	Result – Remark	Verdict
4.8.3.5.1 of IEC 62109-2	General	The PCE provides an integrated RCDs.	P
	Where required by Table 30, the inverter shall provide residual current monitoring that functions whenever the inverter is connected to the mains with the automatic disconnection means closed.	The residual current will be measuring before start up.	P
	The residual current monitoring means shall measure the total (both a.c. and d.c. components) RMS current.	Considered.	P
	As indicated in Table 30 for different inverter types, array types, and inverter isolation levels, detection may be required for excessive continuous residual current, excessive sudden changes in residual current, or both, according to the following limits:	Considered.	P
	a) Continuous residual current: The inverter shall disconnect within 0,3 s and indicate a fault in accordance with 13.9 if the continuous residual current exceeds:	See appended table.	P
	- maximum 300 mA for inverters with continuous output power rating ≤ 30 kV;	See appended table.	P
	- maximum 10 mA per kVA of rated continuous output power for inverters with continuous output power rating > 30 kVA.		N/A
	The inverter may attempt to re-connect if the array insulation resistance meets the limit in 4.8.2.		P
	b) Sudden changes in residual current: The inverter shall disconnect from the mains within the time specified in Table 31	See appended table.	P
	The inverter indicates a fault in accordance with 13.9, if a sudden increase in the RMS residual current is detected exceeding the value in the table.	See appended table.	P
	- monitoring for the continuous condition in a) is not required for an inverter with isolation complying with 4.8.3.3;		P
	- monitoring for the sudden changes in b) is not required for an inverter with isolation complying with 4.8.3.2.		P
	The inverter may attempt to re-connect if the array insulation resistance meets the limit in 4.8.2.		P
4.8.3.5.2 of IEC 62109-2	Test for detection of excessive continuous residual current: test repeated 5 times and time to disconnect shall not exceed 0,3 s.	See appended table.	P
4.8.3.5.3 of IEC 62109-2	Test for detection of sudden changes in residual current repeated 5 times and each of the 5 results shall not exceed the time limit indicated in for each row (30mA, 60mA and 150mA) of Table 31.	See appended table.	P
4.8.3.6 of IEC 62109-2	Systems located in closed electrical operating areas	No located in closed electrical operating areas.	N/A



IEC/EN 62109-1, IEC/EN 62109-2			
Clause	Requirement – Test	Result – Remark	Verdict
	The protection against shock hazard is not required if the installation information provided with the inverter indicates the restriction for use in a closed electrical operating area, and		N/A
	Installation information indicates what forms of shock hazard protection are and are not provided integral to the inverter, in accordance with 5.3.2.7.		N/A
	The inverter shall be marked as in 5.2.2.6.		N/A

5	MARKING AND DOCUMENTATION		P
5.1	Marking		P
5.1.1	General	See below	P
	Equipment shall bear markings as specified in 5.1 and 5.2	The marking plate is on the outer surface of enclosure.	P
	Graphic symbols may be used and shall be in accordance with Annex C or IEC 60417 as applicable.	All used graphic symbols are in accordance with Annex C.	P
	Graphic symbols shall be explained in the documentation provided with the PCE.	The explanations are provided in the manual.	P
5.1.2	Durability of markings	See below	P
	Markings required by this clause to be located on the PCE shall remain clear and legible under conditions of NORMAL USE and resist the effects of cleaning agents specified by the manufacturer	After this test, the markings are clearly legible. There was neither loose nor curling on the edge of label.	P
5.1.3	Identification		P
	The equipment shall, as a minimum, be permanently marked with:	See below	P
	a) the name or trade mark of the manufacturer or supplier		P
	b) model number, name or other means to identify the equipment	The model name is provided on the label.	P
	c) a serial number, code or other marking allowing identification of manufacturing location and the manufacturing batch or date within a three month time period.	The serial number is provided on the label.	P
5.1.4	Equipment ratings		P
	Unless otherwise specified in another part of IEC 62109, the following ratings, as applicable shall be marked on the equipment:	See below	P
	– input voltage, type of voltage (a.c. or d.c.), frequency, and max. continuous current for each input	The input voltage, type of voltage (d.c.) and max. continuous current for each input are marked on the marking label.	P
	– output voltage, type of voltage (a.c. or d.c.), frequency, max. continuous current, and for a.c. outputs, either the power or power factor for each output	The output voltage type of voltage (a.c.), frequency, max. continuous current and power factor for each output are marked on the marking label.	P



IEC/EN 62109-1, IEC/EN 62109-2			
Clause	Requirement – Test	Result – Remark	Verdict
	– the ingress protection (IP) rating as in 6.3 below	IP65 is marked on the label.	P
5.1.4 of IEC 62109-2	Replacement: In addition to the markings required in other clauses of Part 1 and elsewhere in this Part 2, the ratings in Table 32 shall be plainly and permanently marked on the inverter, where it is readily visible after installation. Only those ratings that are applicable based on the type of inverter are required.	The rating mark plate has been placed on the front enclosure and it is visible after mounted.	P
	PV input ratings:	See below	P
	– V _{max} PV (absolute maximum) (d.c. V)	600 d.c. V	P
	– I _{sc} PV (absolute maximum) (d.c. A)	2x15 d.c. A	P
	a.c. output ratings:	See below	P
	– Voltage (nominal or range) (a.c. V)	230 a.c. V	P
	– Current (maximum continuous) (a.c. A)	HYD 6000-ES: Max.27.3 HYD 5000-ES: Max.22.8 HYD 4600-ES: Max.21.0 HYD 4000-ES: Max.18.2 HYD 3600-ES: Max.16.0 HYD 3000-ES: Max.13.7	P
	– Frequency (nominal or range) (Hz)	50Hz	P
	– Power (maximum continuous) (W or VA)	HYD 6000-ES: 6000VA HYD 5000-ES: 5000VA HYD 4600-ES: 4600VA HYD 4000-ES: 4000VA HYD 3600-ES: 3600VA HYD 3000-ES: 3000VA	P
	– Power factor range	0.80 lead-0.80 lag	P
	a.c input ratings:		P
	– Voltage (nominal or range) (a.c. V)	230 a.c. V	P
	– Current (maximum continuous) (a.c. A)	HYD 6000-ES: 27.3 HYD 5000-ES: 22.8 HYD 4600-ES: 21.0 HYD 4000-ES: 18.2 HYD 3600-ES: 16.0 HYD 3000-ES: 13.7	P
	– Frequency (nominal or range) (Hz)	50Hz	P
	d.c input (other than PV) ratings:	External battery can provide dc voltage to PCE.	P
	– Voltage (nominal or range) (d.c. V)	42-58d.c. V	P
	– Current (maximum continuous) (d.c. A)	70d.c. A	P
	d.c. output ratings:	For charging battery	P
	– Voltage (nominal or range) (d.c. V)	42-58d.c. V	P
	– Current (maximum continuous) (d.c. A)	66d.c. A	P
	Protective class (I or II or III)	Class I	P
	Ingress protection (IP) rating per part 1	IP 65	P
5.1.5	Fuse identification	See below.	P



IEC/EN 62109-1, IEC/EN 62109-2			
Clause	Requirement – Test	Result – Remark	Verdict
	Marking shall be located adjacent to each fuse or fuseholder, or on the fuseholder, or in another location provided that it is obvious to which fuse the marking applies, giving the fuse current rating and where fuses of different voltage rating value could be fitted, the fuse voltage rating.		N/A
	Where fuses with special fusing characteristics such as time delay or breaking capacity are necessary, the type shall also be indicated		N/A
	For fuses not located in operator access areas and for soldered-in fuses located in operator access areas, it is permitted to provide an unambiguous cross-reference (for example, F1, F2, etc.) to the servicing instructions which shall contain the relevant information.	The fuse rating marked on the circuit diagram and maintenance manual.	P
5.1.6	Terminals, Connections, and Controls	See below	P
	If necessary for safety, an indication shall be given of the purpose of Terminals, connectors, controls, and indicators, and their various positions, including any connections for coolant fluids such as water and drainage. The symbols in Annex C may be used, and where there is insufficient space, symbol 9 of Annex C may be used.	The indications were provided adjacent to Battery terminals , AC and DC quickConnector.	P
	Push-buttons and actuators of emergency stop devices, and indicator lamps used only to indicate a warning of danger or the need for urgent action shall be coloured red.	No such device	P
	A multiple-voltage unit shall be marked to indicate the particular voltage for which it is set when shipped from the factory. The marking is allowed to be in the form of a paper tag or any other nonpermanent material.	No such device	P
	A unit with d.c. terminals shall be plainly marked indicating the polarity of the connections, with:	See below	P
	– the sign “+” for positive and “-”, for negative; or	The “+” and “-” marking were provided adjacent to the DC input terminals and battery terminals.	P
	– a pictorial representation illustrating the proper polarity where the correct polarity can be unambiguously determined from the representation	No pictorial representation illustration used.	N/A
5.1.6.1	Protective Conductor Terminals		P
	The means of connection for the protective earthing conductor shall be marked with:	See below	P
	– symbol 7 of Annex C; or	The symbol of annex C was marked adjacent to the PE terminal.	P
	– the letters “PE”; or	Symbol 7 of Annex C was used.	N/A
	– the colour coding green-yellow.	Green-yellow wire was used as protective conductor.	P
5.1.7	Switches and circuit-breakers	Approved switch was used for all models.	P



IEC/EN 62109-1, IEC/EN 62109-2			
Clause	Requirement – Test	Result – Remark	Verdict
	The on and off-positions of switches and circuits breakers shall be clearly marked. If a push-button switch is used as the power switch, symbols 10 and 16 of Annex C may be used to indicate the on-position, or symbols 11 and 17 to indicate the off-position, with the pair of symbols (10 and 16, or 11 and 17) close together.	“ON” indicated the on-position of DC switch. “OFF” indicated the off-position of DC switch.	P
5.1.8	Class II Equipment	Class I equipment.	N/A
	Equipment using Class II protective means throughout shall be marked with symbol 12 of Annex C. Equipment which is only partially protected by DOUBLE INSULATION or REINFORCED INSULATION shall not bear symbol 12 of Table Annex C.		N/A
	Where such equipment has provision for the connection of an earthing conductor for functional reasons (see 7.3.6.4) it shall be marked with symbol 6 of Annex C		N/A
5.1.9	Terminal boxes for External Connections	No such parts.	N/A
	Where required by note 1 of Table 2 as a result of high temperatures of terminals or parts in the wiring compartment, there shall be a marking, visible beside the terminal before connection, of either:		N/A
	a) the minimum temperature Rating and size of the cable to be connected to the TERMINALS; or		N/A
	b) a marking to warn the installer to consult the installation instruction. Symbol 9 of Table D-1 is an acceptable marking		N/A
5.2	Warning markings		P
5.2.1	Visibility and legibility requirements for warning markings	See below	P
	Warning markings shall be legible, and shall have minimum dimensions as follows:		P
	– Printed symbols shall be at least 2,75 mm high	The symbols were at least 2.75 mm high.	P
	– Printed text characters shall be at least 1.5 mm high and shall contrast in colour with the background	The text characters were at least 1.5 mm high.	P
	– Symbols or text that are moulded, stamped or engraved in a material shall have a character height of at least 2,0 mm, and if not contrasting in colour from the background, shall have a depth or raised height of at least 0,5 mm.	The symbols or text are marking on the label.	N/A
	If it is necessary to refer to the instruction manual to preserve the protection afforded by the equipment, the equipment shall be marked with symbol 9 of Annex C	The symbol 9 of Annex C was provided on the label.	P
	Symbol 9 of Annex C is not required to be used adjacent to symbols that are explained in the manual	All symbols are explained in the manual.	P
5.2.2	Content for warning markings	See below	P



IEC/EN 62109-1, IEC/EN 62109-2			
Clause	Requirement – Test	Result – Remark	Verdict
5.2.2.1	Ungrounded heatsinks and similar parts	All accessible metal parts were grounded.	N/A
	An ungrounded heat sink or other part that may be mistaken for a grounded part and involves a risk of electric shock in accordance with 7.3 shall be marked with symbol 13 of Annex C, or equivalent. The marking may be on or adjacent to the heatsink and shall be clearly visible when the PCE is disassembled to the extent that a risk of contact with the heatsink exists.		N/A
5.2.2.2	Hot Surfaces		P
	A part of the PCE that exceeds the temperature limits specified in 4.3.2 shall be marked with symbol 14 of Annex C or equivalent.	The symbol 14 of Annex C provided on the warning label which located on the surface of enclosure.	P
5.2.2.3	Coolant	No coolant contained within the equipment.	N/A
	A unit containing coolant that exceeds 70 °C shall be legibly marked externally where readily visible after installation with symbol 15 of Annex C. The documentation shall provide a warning regarding the risk of burns from hot coolant, and either:		N/A
	a) statement that coolant system servicing is to be done only by SERVICE PERSONNEL, or		N/A
	b) instructions for safe venting, draining, or otherwise working on the cooling system, if these operations can be performed without OPERATOR access to HAZARDS internal to the equipment		N/A
5.2.2.4	Stored energy	See below	P
	Where required by 7.3.9.2 or 7.4.2 the PCE shall be marked with Symbol 21 of Annex C and the time to discharge capacitors to safe voltage and energy levels shall accompany the symbol.	The symbol 21 of Annex C and “5min” were provided on the label.	P
5.2.2.5	Motor guarding	Considered.	P
	Where required by 8.2 a marking shall be provided where it is visible to service personnel before removal of a guard, warning of the hazard and giving instructions for safe servicing (for example disconnection of the source before removing the guard).	Considered.	P
5.2.2.6 of IEC 62109-2	Inverters for closed electrical operating areas	Considered.	P
	Where required by 4.8.3.6, an inverter not provided with full protection against shock hazard on the PV array shall be marked with a warning that the inverter is only for use in a closed electrical operating area, and referring to the installation instructions.	Considered.	P
5.2.3	Sonic hazard markings and instructions	No any hazardous noise level from the equipment.	N/A
	If required by 10.2.1 a PCE shall:		N/A



IEC/EN 62109-1, IEC/EN 62109-2			
Clause	Requirement – Test	Result – Remark	Verdict
	a) be marked to warn the operator of the sonic pressure hazard; or		N/A
	b) be provided with installation instructions that specify how the installer can ensure that the sound pressure level from equipment at its point of use after installation, will not reach a value, which could cause a hazard. These instructions shall include the measured sound pressure level, and shall identify readily available and practicable protective materials or measures which may be used.		N/A
5.2.4	Equipment with multiple sources of supply	See below	P
	A PCE with connections for multiple energy sources shall be marked with symbol 13 of Annex C and the manual shall contain the information required in 5.3.4.	Marked with symbol 13 of Annex C and explain in user manual.	P
	The symbol shall be located on the outside of the unit or shall be prominently visible behind any cover giving access to hazardous parts.		P
5.2.5	Excessive touch current	No touch current exceeded 3,5mA a.c. Under any operation conditions.	N/A
	Where required by 7.3.6.3.7 the PCE shall be marked with symbol 15 of Annex C. See also 5.3.2 for information to be provided in the installation manual.		N/A
5.3	Documentation		P
5.3.1	General		P
	The documentation provided with the PCE shall provide the information needed for the safe operation, installation, and (where applicable) maintenance of the equipment. The documentation shall include the items required in 5.3.2 through 5.3.4, and the following:	Considered.	P
	a) explanations of equipment markings, including symbols used	Considered.	P
	b) location and function of terminals and controls	Considered.	P
	c) all ratings or specifications that are necessary to safely install and operate the PCE, including the following environmental ratings along with an explanation of their meaning and any resulting installation requirements:	Considered.	P
	– ENVIRONMENTAL CATEGORY as per 6.1	Outdoor and indoor	P
	– WET LOCATIONS classification for the intended external environment as per 6.1	0%R.H.~100%R.H.	P
	– POLLUTION DEGREE classification for the intended external environment as per 6.2	PD 3	P
	– INGRESS PROTECTION rating as per 6.3	IP65	P



IEC/EN 62109-1, IEC/EN 62109-2			
Clause	Requirement – Test	Result – Remark	Verdict
	– Ambient temperature and relative humidity ratings	-25°C to +60°C,0-100%R.H.	P
	– MAXIMUM altitude rating	Up to 2000m.	P
	– OVERVOLTAGE CATEGORY assigned to each input and output port as per 7.3.7.1.2, accompanied by guidance regarding how to ensure that the installation complies with the required overvoltage categories;	PV side: OVCII AC side: OVCIII	P
	d) a warning that when the photovoltaic array is exposed to light, it supplies a d.c. voltage to the PCE	Considered.	P
5.3.1.1	Language		P
	Instructions related to safety shall be in a language that is acceptable in the country where the equipment is to be installed.	Considered.	P
5.3.1.2	Format		P
	In general, the documentation must be provided in printed form and is to be delivered with the equipment.	Considered.	P
	For equipment which requires the use of a computer for both installation and operation, documentation may be provided in electronic format without accompanying printed format.	Considered.	P
5.3.2	Information related to installation		P
	The documentation shall include installation and where applicable, specific commissioning instructions and, if necessary for safety, warnings against hazards which could arise during installation or commissioning of the equipment. The information provided shall include:	Considered.	P
	a) assembly, location, and mounting requirements:	Reference installation instruction.	P
	b) ratings and means of connection to each source of supply and any requirements related to wiring and external controls, colour coding of leads, disconnection means, or overcurrent protection needed, including instructions that the installation position shall not prevent access to the disconnection means;	Reference installation instruction.	P
	c) ratings and means of connection of any outputs from the PCE, and any requirements related to wiring and external controls, colour coding of leads, or overcurrent protection needed;	Reference installation instruction.	P
	d) explanation of the pin-out of connectors for external connections, unless the connector is used for a standard purpose (e.g. RS 232)	Reference installation instruction.	P
	e) ventilation requirements;	Reference installation instruction.	P



IEC/EN 62109-1, IEC/EN 62109-2			
Clause	Requirement – Test	Result – Remark	Verdict
	f) requirements for special services, for example cooling liquid;	No special services.	N/A
	g) instructions and information relating to sound pressure level if required by 10.2.1;	Pressure level was not exceed 10.2.1 requirement.	N/A
	h) where required by 14.8.1.3, instructions for the adequate ventilation of the room or location in which PCE containing vented or valve-regulated batteries is located, to prevent the accumulation of hazardous gases;	Sealed lead acid battery, Vented battery, Gel battery and lithium battery of external battery pack (EBP) used. The detail installation and maintenance explanations are provided in the manufacturer's EBP of manual.	N/A
	i) tightening torque to be applied to wiring terminals;	Reference installation instruction.	P
	j) values of backfeed short-circuit currents available from the PCE on input and output conductors under fault conditions, if those currents exceeds the max. rated current of the circuit, as per 4.4.4.6;	The backfeed current was prevented.	N/A
	k) for each input to the PCE, the max value of short-circuit current available from the source, for which the PCE is designed; and	Considered.	P
	l) compatibility with RCD and RCM;	RCD is built-in the PCE.	P
	m) instructions for protective earthing, including the information required by 7.3.6.3.7 if a second protective earthing conductor is to be installed:	Reference installation instruction.	P
	n) where required by 7.3.8, the installation instructions shall include the following or equivalent wording:	RCD is built-in the PCE.	N/A
	“This product can cause a d.c. current in the external protective earthing conductor. Where a residual current-operated protective (RCD) or monitoring (RCM) device is used for protection in a case of direct or indirect contact, only an RCD or RCM of Type B is allowed on the supply side of this product.”		N/A
	o) for PCE intended to charge batteries, the battery nominal voltage rating, size, and type	The explanations are provided in the manual.	P
	p) PV array configuration information, such as ratings, whether the array is to be grounded or floating, any external protection devices needed, etc.	PV array should be floating configuration to be connected to PCE, relant information had shown on the installation manual.	P
5.3.2.1 of IEC 62109-2	Ratings		P



IEC/EN 62109-1, IEC/EN 62109-2			
Clause	Requirement – Test	Result – Remark	Verdict
	Subclause 5.3.2 of Part 1 requires the documentation to include ratings information for each input and output. For inverters this information shall be as in Table 33 below. Only those ratings that are applicable based on the type of inverter are required.		P
	PV input quantities :	See below	P
	– Vmax PV (absolute maximum) (d.c. V)	600 d.c. V	P
	– PV input operating voltage range (d.c. V)	90-580 d.c. V	P
	– Maximum operating PV input current (d.c. A)	2x12 d.c. A	P
	– Isc PV (absolute maximum) (d.c. A)	2x15 d.c. A	P
	– Max. inverter backfeed current to the array (a.c. or d.c. A)	0	P
	a.c. output quantities:	See below	P
	– Voltage (nominal or range) (a.c. V)	230a.c. V	P
	– Current (maximum continuous) (a.c. A)	HYD 6000-ES: Max.27.3 HYD 5000-ES: Max.22.8 HYD 4600-ES: Max.21.0 HYD 4000-ES: Max.18.2 HYD 3600-ES: Max.16.0 HYD 3000-ES: Max.13.7	P
	Current (inrush) (a.c. A, peak and duration)	0.8A /1μs	P
	– Frequency (nominal or range) (Hz)	50Hz	P
	– Power (maximum continuous) (W or VA)	HYD 6000-ES: 6000VA HYD 5000-ES: 5000VA HYD 4600-ES: 4600VA HYD 4000-ES: 4000VA HYD 3600-ES: 3600VA HYD 3000-ES: 3000VA	P
	– Power factor range	0.80 lead-0.80 lag	P
	– Maximum output fault current (a.c. A, peak and duration or RMS)	100.0A per phase/1μs	P
	– Maximum output overcurrent protection (a.c. A)	HYD 6000-ES: 29.0 HYD 5000-ES: 24.1 HYD 4600-ES: 21.0 HYD 4000-ES: 19.3 HYD 3600-ES: 17.4 HYD 3000-ES: 14.5	P
	a.c. input quantities:		P
	– Voltage (nominal or range) (a.c. V)	230 a.c. V	P
	– Current (maximum continuous) (a.c. A)	HYD 6000-ES: 27.3 HYD 5000-ES: 22.8 HYD 4600-ES: 21.0 HYD 4000-ES: 18.2 HYD 3600-ES: 16.0 HYD 3000-ES: 13.7	P



IEC/EN 62109-1, IEC/EN 62109-2			
Clause	Requirement – Test	Result – Remark	Verdict
	– Current (inrush) (a.c. A, peak and duration)	No inrush current	P
	– Frequency (nominal or range) (Hz)	50Hz	P
	d.c input (other than PV) quantities:	External battery can provide dc voltage to PCE.	P
	– Voltage (nominal or range) (d.c. V)	42-58d.c. V	P
	– Nominal battery voltage (d.c. V)	48 d.c. V	P
	– Current (maximum continuous) (d.c. A)	70d.c. A	P
	d.c. output quantities:	For charging battery	P
	– Voltage (nominal or range) (d.c. V)	42-58d.c. V	P
	– Nominal battery voltage (d.c. V)	48 d.c. V	P
	– Current (maximum continuous) (d.c. A)	65d.c. A	P
	Protective class (I or II or III)	Class I	P
	Ingress protection (IP) rating per part 1	IP65	P
5.3.2.2 of IEC 62109-2	Grid-interactive inverter setpoints		N/A
	For a grid-interactive unit with field adjustable trip points, trip times, or reconnect times, the presence of such controls, the means for adjustment, the factory default values, and the limits of the ranges of adjustability shall be provided in the documentation for the PCE or in other format such as on a website.	No adjustable setting available. Only the factory default values, however the adjustment shall be performed by distribution network operator.	N/A
5.3.2.3 of IEC 62109-2	Transformers and isolation	Transformerless PCE	N/A
	An inverter shall be provided with information to the installer regarding whether an internal isolation transformer is provided, and if so, what level of insulation (functional, basic, reinforced, or double) is provided by that transformer. The instructions shall also indicate what the resulting installation requirements are regarding such things as earthing or not earthing the array, providing external residual current detection devices, requiring an external isolation transformer, etc.		N/A
5.3.2.4 of IEC 62109-2	Transformers required but not provided	Transformerless PEC.	N/A
	An inverter that requires an external isolation transformer not provided with the unit, shall be provided with instructions that specify the configuration type, electrical ratings, and environmental ratings for the external isolation transformer with which it is intended to be used.		N/A
5.3.2.5 of IEC 62109-2	PV modules for non-isolated inverters		P



IEC/EN 62109-1, IEC/EN 62109-2			
Clause	Requirement – Test	Result – Remark	Verdict
	Non-isolated inverters shall be provided with installation instructions that require PV modules that have an IEC 61730 Class A rating. If the maximum AC mains operating voltage is higher than the PV array maximum system voltage then the instructions shall require PV modules that have a maximum system voltage rating based upon the AC mains voltage.	Considered.	P
5.3.2.6 of IEC 62109-2	Non-sinusoidal output waveform information	Sinusoidal output waveform.	N/A
	The instruction manual for a stand-alone inverter not complying with 4.7.5.2 shall include a warning that the waveform is not sinusoidal, that some loads may experience increased heating, and that the user should consult the manufacturers of the intended load equipment before operating that load with the inverter. The inverter manufacturer shall provide information regarding what types of loads may experience increased heating, recommendations for maximum operating times with such loads, and shall specify the THD, slope, and peak voltage of the waveforms as determined by the testing in 4.7.5.3.2 through 4.7.5.3.4.		N/A
5.3.2.7 of IEC 62109-2	Systems located in closed electrical operating areas	No such parts.	N/A
	Where required by 4.8.3.6, an inverter not provided with full protection against shock hazard on the PV array shall be provided with installation instructions requiring that the inverter and the array must be installed in closed electrical operating areas, and indicating which forms of shock hazard protection are and are not provided integral to the inverter (for example the RCD, isolation transformer complying with the 30 mA touch current limit, or residual current monitoring for sudden changes).		N/A
5.3.2.8 of IEC 62109-2	Stand-alone inverter output circuit bonding		P
	Where required by 7.3.10, the documentation for an inverter shall include the following:		P
	– if output circuit bonding is required but is not provided integral to the inverter, the required means shall be described in the installation instructions, including which conductor is to be bonded and the required current carrying capability or cross-section of the bonding means;		P
	– if the output circuit is intended to be floating, the documentation for the inverter shall indicate that the output is floating.		N/A



IEC/EN 62109-1, IEC/EN 62109-2			
Clause	Requirement – Test	Result – Remark	Verdict
5.3.2.9 of IEC 62109-2	Protection by application of RCD's	See below.	N/A
	Where the requirement for additional protection in 4.8.3.1 is met by requiring an RCD that is not provided integral to the inverter, as allowed by 4.8.3.4, the installation instructions shall state the need for the RCD, and shall specify its rating, type, and required circuit location.	The RCD protection is provided integral to the inverter.	N/A
5.3.2.10 of IEC 62109-2	Remote indication of faults	See below.	P
	The installation instructions shall include an explanation of how to properly make connections to (where applicable), and use, the electrical or electronic fault indication required by 13.9.	The instructions are specified in section "Warning List" of the product manual.	P
5.3.2.11 of IEC 62109-2	External array insulation resistance measurement and response	Subclause 4.8.2.1 compliance.	N/A
	The installation instructions for an inverter for use with ungrounded arrays that does not incorporate all the aspects of the insulation resistance measurement and response requirements in 4.8.2.1, must include:	The PCE incorporates array insulation resistance measurement.	N/A
	– for isolated inverters, an explanation of what aspects of array insulation resistance measurement and response are not provided, and an instruction to consult local regulations to determine if any additional functions are required or not;		N/A
	– for non-isolated inverters:		N/A
	• an explanation of what external equipment must be provided in the system, and		N/A
	• what the setpoints and response implemented by that equipment must be, and		N/A
	• how that equipment is to be interfaced with the rest of the system.		N/A
5.3.2.12 of IEC 62109-2	Array functional grounding information	No such part.	N/A
	Where approach a) of 4.8.2.2 is used, the installation instructions for the inverter shall include all of the following:		N/A
	a) the value of the total resistance between the PV circuit and ground integral to the inverter;		N/A
	b) the minimum array insulation resistance to ground that system designer or installer must meet when selecting the PV panel and system design, based on the minimum value that the design of the PV functional grounding in the inverter was based on;		N/A



IEC/EN 62109-1, IEC/EN 62109-2			
Clause	Requirement – Test	Result – Remark	Verdict
	c) the minimum value of the total resistance R = VMAX PV/30 mA that the system must meet, with an explanation of how to calculate the total;		N/A
	d) a warning that there is a risk of shock hazard if the total minimum resistance requirement is not met.		N/A
5.3.2.13 of IEC 62109-2	Stand-alone inverters for dedicated loads		N/A
	Where the approach of 4.7.5.5 is used, the installation instructions for the inverter shall include a warning that the inverter is only to be used with the dedicated load for which it was evaluated, and shall specify the dedicated load.		N/A
5.3.2.14 of IEC 62109-2	Identification of firmware version(s)	See below	P
	An inverter utilizing firmware for any protective functions shall provide means to identify the firmware version. This can be a marking, but the information can also be provided by a display panel, communications port or any other type of user interface.	The firmware version is displayed on LCD display panel and disclosed by communication interface.	P
5.3.3	Information related to operation		P
	Instructions for use shall include any operating instructions necessary to ensure safe operation, including the following, as applicable:	See below	P
	– Instructions for adjustment of controls including the effects of adjustment;	Provided in the owner's manual.	P
	– Instructions for interconnection to accessories and other equipment, including indication of suitable accessories, detachable parts and any special materials;	Provided in the owner's manual.	P
	– Warnings regarding the risk of burns from surfaces permitted to exceed the temperature limits of 4.3.2 and required operator actions to reduce the risk; and	The temperature of surfaces did not exceed the limit of 4.3.2, however the 14 symbol was provided on the label.	P
	– Instructions, that if the equipment is used in a manner not specified by the manufacturer, the protection provided by the equipment may be impaired.	Provided in the user's manual.	P
5.3.4	Information related to maintenance		P
	Maintenance instructions shall include the following:		P
	– Intervals and instructions for any preventive maintenance that is required to maintain safety (for example air filter replacement or periodic re-tightening of terminals);	Provided in the user's manual.	P
	– Instructions for accessing operator access areas, if any are present, including a warning not to enter other areas of the equipment;	Provided in the user's manual.	P



IEC/EN 62109-1, IEC/EN 62109-2			
Clause	Requirement – Test	Result – Remark	Verdict
	– Part numbers and instructions for obtaining any required operator replaceable parts;	No any operator replaceable parts. Only for authorized service personnel.	N/A
	– Instructions for safe cleaning (if recommended)	Provided in the user's manual.	P
	– Where there is more than one source of supply energizing the PCE, information shall be provided in the manual to indicate which disconnect device or devices are required to be operated in order to completely isolate the equipment.	Provided in the user's manual.	P
5.3.4.1	Battery maintenance	External battery module used, and evaluated in the final product.	P
	Where required by 14.8.5, the documentation shall include the applicable items from the following list of instructions regarding maintenance of batteries:	See below.	P
	– Servicing of batteries should be performed or supervised by personnel knowledgeable about batteries and the required precautions	The explanations are provided in the installation manual.	P
	– When replacing batteries, replace with the same type and number of batteries or battery packs	The detail installation and maintenance explanations are provided in the manufacturer's EBP of manual.	N/A
	– General instructions regarding removal and installation of batteries	See above.	N/A
	– CAUTION: Do not dispose of batteries in a fire. The batteries may explode.	See above.	N/A
	– CAUTION: Do not open or damage batteries. Released electrolyte is harmful to the skin and eyes. It may be toxic.	See above.	N/A
	– CAUTION: A battery can present a risk of electrical shock and high short-circuit current. The following precautions should be observed when working on batteries:	See above.	N/A
	a) Remove watches, rings, or other metal objects.	See above.	N/A
	b) Use tools with insulated handles.	See above.	N/A
	c) Wear rubber gloves and boots.	See above.	N/A
	d) Do not lay tools or metal parts on top of batteries	See above.	N/A
	e) Disconnect charging source prior to connecting or disconnecting battery terminals	See above.	N/A



IEC/EN 62109-1, IEC/EN 62109-2			
Clause	Requirement – Test	Result – Remark	Verdict
	f) Determine if battery is inadvertently grounded. If inadvertently grounded, remove source from ground. Contact with any part of a grounded battery can result in electrical shock. The likelihood of such shock can be reduced if such grounds are removed during installation and maintenance (applicable to equipment and remote battery supplies not having a grounded supply circuit).	See above.	N/A

6	ENVIRONMENTAL REQUIREMENTS AND CONDITIONS		P
	The manufacturer shall rate the PCE for the following environmental conditions:	See below	P
	– ENVIRONMENTAL CATEGORY, as in 6.1 below	See below	P
	– Suitability for WET LOCATIONS or not	The PCE is for outdoor.	P
	– POLLUTION DEGREE rating in 6.2 below	See 6.2.	P
	– INGRESS PROTECTION (IP) rating, as in 6.3 below	See 6.3.	P
	– Ultraviolet (UV) exposure rating, as in 6.4 below	The PCE is for outdoor.	P
	– Ambient temperature and relative humidity ratings, as in 6.5 below	See 6.5.	P
6.1	Environmental categories and minimum environmental conditions		P
6.1.1	Outdoor		P
6.1.2	Indoor, unconditioned	The PCE is for outdoor.	N/A
6.1.3	Indoor, conditioned	The PCE is for outdoor.	N/A
6.2	Pollution degree	PD3	P
6.3	Ingress Protection	IP65	P
6.4	UV exposure	The displayer panel and connection terminals could protect against UV radiation.	P
6.5	Temperature and humidity	-25°C~+60°C, 0%~100% R.H.	P

7	PROTECTION AGAINST ELECTRIC SHOCK AND ENERGY HAZARDS		P
7.1	General	See below	P
7.2	Fault conditions	Refer to table 4.4.	P
7.3	Protection against electric shock		P
7.3.1	General	See below	P
7.3.2	Decisive voltage classification		P
7.3.2.1	Use of decisive voltage class (DVC)		P
7.3.2.2	Limits of DVC (according table 6)	DVC-C is classified for d.c. input and a.c. output circuit. DVC-A is classified for circuitry of communication ports.	P
7.3.2.3	Short-terms limits of accessible voltages under fault conditions		N/A
7.3.2.4	Requirements for protection (according table 7)	Considered	P



IEC/EN 62109-1, IEC/EN 62109-2			
Clause	Requirement – Test	Result – Remark	Verdict
7.3.2.5	Connection to PELV and SELV circuits	DVC-A is classified for communication ports.	P
7.3.2.6	Working voltage and DVC	See below	P
7.3.2.6.1	General	Considered	P
7.3.2.6.2	AC working voltage (see Figure 2)	Considered	P
7.3.2.6.3	DC working voltage (see Figure 3)	Considered	P
7.3.2.6.4	Pulsating working voltage (see Figure 4)	Considered	P
7.3.3	protective separation		P
	Protective separation shall be achieved by:	See below	P
	<ul style="list-style-type: none"> ▪ double or reinforced insulation, or 	The double or reinforced insulation was provided between: 1) DC input circuits and communication circuits; 2) Battery circuits and communication circuits; 3) AC output circuits and communication circuits.	P
	<ul style="list-style-type: none"> ▪ protective screening, i.e. by a conductive screen connected to earth by protective bonding in the PCE, or connected to the protective earth conductor itself, whereby the screen is separated from live parts by at least basic insulation, or 	All accessible metal parts were earthed and separated from live parts by at least basic insulation.	P
	<ul style="list-style-type: none"> ▪ protective impedance comprising limitation of current per 7.3.5.3 and of discharged energy per 7.3.5.4, or 	No such device.	N/A
	<ul style="list-style-type: none"> ▪ limitation of voltage according to 7.3.5.4. 	No such device.	N/A
	The protective separation shall be fully and effectively maintained under all conditions of intended use of the PCE	Considered	P
7.3.4	Protection against direct contact		P
7.3.4.1	General	See below	P
	Protection against direct contact is employed to prevent persons from touching live parts that do not meet the requirements of 7.3.5 and shall be provided by one or more of the measure given in 7.3.4.2 (enclosures and barriers) and 7.3.4.3 (insulation).	See 7.3.4.2 and 7.3.4.3	P
	Open type sub-assemblies and devices do not require protective measures against direct contact but the instruction provided with the equipment must indicate that such measures must be provided in the end equipment or in the installation.	No such device.	N/A
	Product intended for installation in CLOSED ELECTRICAL OPERATING AREAS, (see 3.9) need not have protective measures against direct contact, except as required by 7.3.4.2.4.	No such device.	N/A
7.3.4.2	Protection by means of enclosures and barriers		P
	The following requirements apply where protection against contact with live parts is provided by enclosures or barriers, not by insulation in accordance with 7.3.4.3.	Considered	P
7.3.4.2.1	General	See below	P



IEC/EN 62109-1, IEC/EN 62109-2			
Clause	Requirement – Test	Result – Remark	Verdict
	Parts of enclosures and barriers that provide protection in accordance with these requirements shall not be removable without the use of a tool (see 7.3.4.2.3).	Considered	P
	Polymeric materials used to meet these requirements shall also meet the requirements of 13.6	Considered	P
7.3.4.2.2	Access probe criteria		P
	Protection is considered to be achieved when the separation between the test probes and live parts, when tested as described below, is as follows:	See below	P
	a) decisive voltage classification A, (DVC A) - the probe may touch the live parts	Considered	P
	b) decisive voltage classification B, (DVC B) - the probe must not touch bare live parts	No DVC-B in the PCE.	N/A
	c) decisive voltage classification C, (DVC C) – the probe must have adequate clearance to live parts, based on the clearance for Basic insulation using the recurring peak working voltage involved,	Considered	P
7.3.4.2.3	Access probe tests		P
	Compliance with 7.3.4.2.1 is checked by all of the following:		P
	a) Inspection; and	Considered	P
	b) Tests with the test finger (Figure D.1) and test pin (Figure D.2) of 0E, the results of which shall comply with the requirements of 7.3.4.2.1 a), b), and c) as applicable. Probe tests are performed on openings in the enclosures after removal of parts that can be detached or opened by an operator without the use of a tool, including fuseholders, and with operator access doors and covers open. It is permitted to leave lamps in place for this test. Connectors that can be separated by an operator without use of a tool, shall also be tested during and after disconnection. Any movable parts are to be put in the most unfavorable position.	Considered	P
	The test finger and the test pin are applied as above, without appreciable force, in every possible position, except that floor-standing equipment having a mass exceeding 40 kg is not tilted.	Considered	P
	Equipment intended for building-in or rack mounting, or for incorporation in larger equipment, is tested with access to the equipment limited according to the method of mounting detailed in the installation instructions.	No a built-in or rack mounting equipment.	N/A



IEC/EN 62109-1, IEC/EN 62109-2			
Clause	Requirement – Test	Result – Remark	Verdict
	c) Openings preventing the entry of the jointed test finger (Figure D-1 of Annex D) during test b) above, are further tested by means of straight unjointed test finger (Figure D-3 of Annex D), applied with a force of 30 N. If the unjointed finger enters, the test with the jointed finger is repeated except that the finger is applied using any necessary force up to 30 N.	Considered.	P
	d) In addition to a) – c) above, top surfaces of enclosure shall be tested with the IP3X probe of IEC 60529. The test probe shall not penetrate the top surface of the enclosure when probed from the vertical direction $\pm 5^\circ$ only.	Considered.	P
7.3.4.2.4	Service access areas	The PCE is not allowed to remove the covers during installation and maintenance when PCE energized.	P
7.3.4.3	Protection by means of insulation of live parts	See below	N/A
	Where the requirements of 7.3.4.2 are not met, live parts shall be provided with insulation if:	The requirements of 7.3.4.2 are met.	N/A
	– their working voltage is greater than the maximum limit of decisive voltage class A, or		N/A
	– for a DVC A or B circuit, protective separation from adjacent circuit of DVC C is not provided (see note “†” under Table 7)		N/A
7.3.5	Protection in case of direct contact		N/A
7.3.5.1	General		P
	Protection in case of direct contact is required to ensure that contact with live parts does not produce a shock hazard.	See below	P
	The protection against direct contact according to 7.3.4 is not required if the circuit contacted is separated from other circuits according to 7.3.2.3, and:	Considered	P
	– is of decisive voltage class A and complies with 7.3.5.2, or	Only DVC-A classified circuits can be touched directly, see also 7.3.5.2.	P
	– is provided with protective impedance according to 7.3.5.3, or		N/A
	– is limited in voltage according to 7.3.5.4		N/A
	In addition to the measures as given in 7.3.5.2 to 7.3.5.4, it shall be ensured that in the event of error or polarity reversal of connectors no voltages that exceed DVC A can be connected into a circuit with protective separation. This applies for example to plug-in-sub-assemblies or other plug-in devices which can be plugged-in without the use of a tool (key) or which are accessible without the use of a tool.	Considered	P
	Conformity is checked by visual inspection and trial insertion.	Considered	P
7.3.5.2	Protection using decisive voltage class A	Considered	P



IEC/EN 62109-1, IEC/EN 62109-2			
Clause	Requirement – Test	Result – Remark	Verdict
7.3.5.3	Protection by means of protective impedance	No such parts.	N/A
	Circuits and conductive parts do not require protection against direct contact if any connection to circuits of DVC-B or DVC-C is through protective impedance, and the accessible circuit or part is otherwise provided with protective separation from circuits of DVC-B or DVC-C according 7.3.3.		N/A
7.3.5.3.1	Limitation of current through protective impedance	No such parts.	N/A
	The current available through protective impedance to earth and between simultaneously accessible parts, measured at the accessible live parts, shall not exceed a value of 3,5 mA a.c. or 10 mA d.c. under normal and single-fault conditions.		N/A
7.3.5.3.2	Limitation of discharging energy through protective impedance	No such parts.	N/A
	The discharging energy available between simultaneously accessible parts protected by protective impedance shall not exceed the charging voltage and capacitance limits given in Table 9, which applies to both wet and dry locations, under normal and single fault conditions. Refer to figure 8.		N/A
7.3.5.4	Protection by means of limited voltages	No such parts.	N/A
	That portion of a circuit that has its voltage reduced to DVC-A by a voltage divider that complies with the following requirements, and that is otherwise provided with protective separation from circuits of DVC-B or DVC-C according to 7.3.3, does not require protection against direct contact.		N/A
	The voltage divider shall be designed so that under normal and single fault conditions, including faults in the voltage division circuit, the voltage across the output of the voltage divider does not exceed the limit for DVC-A.		N/A
	This type of protection shall not be used in case of protective class II or unearthed circuits, because it relies on protective earth being connected.		N/A
7.3.6	Protection against indirect contact		P
7.3.6.1	General	See below	P
	Protection against indirect contact is required to prevent shock- hazardous current being accessible from conductive parts during an insulation failure. This protection shall comply with the requirements for protective class I (basic insulation plus protective earthing), class II (double or reinforced insulation) or class III (limitation of voltages)	The earthing metal enclosure is complied with protective class I and the circuit of communication is complied with protective class II for accessible communication ports.	P
	That part of a PCE meets the requirements of 7.3.6.2 and 7.3.6.3 is defined as protective class I	Considered	P
	That part of a PCE meets the requirements of 7.3.6.4 is defined as protective class II.	Considered	P
	That part of PCE which meets the requirements of decisive voltage class A and in which no hazardous voltages are derived, is defined as protective class III. No shock hazard is present in such circuits.		N/A



IEC/EN 62109-1, IEC/EN 62109-2			
Clause	Requirement – Test	Result – Remark	Verdict
	Where protection against indirect contact is dependent on means provided during installation, the installation instructions shall provide details of the required means and shall indicate the associated hazards.	Considered	P
7.3.6.2	Insulation between live parts and accessible conductive parts	Considered	P
	Accessible conductive parts of equipment shall be separated from live parts by insulation meeting the requirements of Table 7 or by clearances as specified in 7.3.7.4 and creepages as specified in 7.3.7.5	The clearances specified in 7.3.7.4 and creepage specified in 7.3.7.5 are complied.	P
7.3.6.3	Protective class I – Protective bonding and earthing	See below	P
7.3.6.3.1	General		P
	Equipment of protective class I shall be provided with protective earthing, and with protective bonding to ensure electrical contact between accessible conductive parts and the means of connection for the external protective earthing conductor, except bonding is not required for:	See below	P
	a) accessible conductive parts that are protected by one of the measures in 7.3.5.2 to 7.3.5.4, or	DVC-A classified circuit is considered.	P
	b) accessible conductive parts are separated from live parts of DVC-B or -C using double or reinforced insulation.	Communication circuits are separated from live parts used double or reinforced insulation.	P
7.3.6.3.2	Requirements for protective bonding		P
	Electrical contact with the means of connection of the external protective earthing conductor shall be achieved by one or more of the following means:	See below	P
	a) through direct metallic contact;	The connection of external protective earthing conductor is direct metal contact via a terminal with screw.	P
	b) through other conductive parts which are not removed when the PCE or sub-units are used as intended ;	See above	N/A
	c) through a dedicated protective bonding conductor;	Protective earthing terminal be used.	P
	d) through other metallic components of the PCE		N/A
	Where direct metallic contact is used and one or both of the parts involved is painted or coated, the paint or coating shall be removed in the area of contact, or reliably penetrated, to ensure metal to metal contact.	No painted and coated exsited.	P
	For moving or removable parts, hinges or sliding contacts designed and maintained to have a low resistance are examples of acceptable means if they comply with the requirements of 7.3.6.3.3.	No such parts.	N/A



IEC/EN 62109-1, IEC/EN 62109-2			
Clause	Requirement – Test	Result – Remark	Verdict
	Metal ducts of flexible or rigid construction and metallic sheaths shall not be used as protective bonding conductors, unless the device or material has been investigated as suitable for protective bonding purposes.	No such parts.	N/A
7.3.6.3.3	Rating of protective bonding	The alternative of 7.3.6.3.5 is considered.	P
	Protective bonding shall withstand the highest thermal and dynamic stresses that can occur to the PCE item(s) concerned when they are subjected to a fault connecting live parts to accessible conductive parts. The protective bonding shall remain effective for as long as a fault to the accessible conductive parts persists or until an upstream protective device removes power from the part.		N/A
	Protective bonding shall meet following requirements:		N/A
	a) For PCE with an overcurrent protective device rating of 16 A or less, the impedance of the protective bonding means shall not exceed 0,1 Ω during or at the end of the test below.		N/A
	b) For PCE with an overcurrent protective device rating of more than 16 A, the voltage drop in the protective bonding test shall not exceed 2,5 V during or at the end of the test below.		N/A
	As alternative to a) and b) the protective bonding may designed according to the requirements for the external protective earthing conductor in 7.3.6.3.5, in which case no testing is required.	The alternative of 7.3.6.3.5 was considered.	P
	The impedance of protective bonding means shall be checked by passing a test current through the bond for a period of time as specified below. The test current is based on the rating of the overcurrent protection for the equipment or part of the equipment under consideration, as follows:		N/A
	a) For pluggable equipment type A, the overcurrent protective device is that provided external to the equipment (for example, in the building wiring, in the mains plug or in an equipment rack);		N/A
	b) For pluggable equipment type B and fixed equipment, the maximum rating of the overcurrent protective device specified in the equipment installation instructions to be provided external to the equipment;		N/A
	c) For a circuit or part of the equipment for which an overcurrent protective device is provided as part of the equipment, the rating of the provided overcurrent device.		N/A



IEC/EN 62109-1, IEC/EN 62109-2			
Clause	Requirement – Test	Result – Remark	Verdict
	Voltages are measured from the protective earthing terminal to all parts whose protective bonding means are being considered. The impedance of the protective earthing conductor is not included in the measurement. However, if the protective earthing conductor is supplied with the equipment, it is permitted to include the conductor in the test circuit but the measurement of the voltage drop is made only from the main protective earthing terminal to the accessible part required to be earthed.		N/A
	On equipment where the protective earth connection to a subassembly or to a separate unit is part of a cable that also supplies power to that subassembly or unit, the resistance of the protective bonding conductor in that cable is not included in the protective bond impedance measurements for the subassembly or separate unit, as shown in Figure 11. However, this option is only permitted if the cable is protected by a suitably rated protective device that takes into account the size of the conductor. Otherwise the impedance of the protective bonding conductor between the separate units is to be included, by measuring to the protective earthing terminal where the power source enters the first unit in the system, as shown in Figure 12.		N/A
7.3.6.3.3.1	Test current, duration, and acceptance criteria	The alternative of 7.3.6.3.5 was considered.	N/A
	The test current, duration of the test and acceptance criteria are as follows:		N/A
	a) For PCE with an overcurrent protective device rating of 16 A or less, the test current is 200% of the overcurrent protective device rating, but not less than 32 A, applied for 120s. The impedance of the protective bonding means during and at the end of the test shall not exceed 0,1 Ω .		N/A
	b) For PCE with an overcurrent protective device rating of more than 16 A, the test current is 200% of the overcurrent protective device rating and the duration of the test is as shown in Table 10 below. The voltage drop in the protective bonding means, during and at the end of the test, shall not exceed 2,5 V.		N/A
	c) During and after the test, there shall be no melting, loosening, or other damage that would impair the effectiveness of the protective bonding means.		N/A
	The test current is derived from an a.c or d.c supply source, the output of which is not earthed.		N/A



IEC/EN 62109-1, IEC/EN 62109-2			
Clause	Requirement – Test	Result – Remark	Verdict
	As an alternative to Table 10, where the time-current characteristic of the overcurrent protective device that limits the fault current in the protective bonding means is known because the device is either provided in the equipment or fully specified in the installation instructions, the test duration may be based on that specific device's time-current characteristic,. The tests are conducted for a duration corresponding to the 200% current value on the time-current characteristic.		N/A
7.3.6.3.4	Protective bonding impedance (routine test)	The alternative of 7.3.6.3.5 was considered.	N/A
	If the continuity of the protective bonding is achieved at any point by a single means only (for example a single conductor or single fastener), or if the PCE is assembled at the installation location, then the impedance of the protective bonding shall also be tested as a routine test. The test shall be as in 7.3.6.3.3, except for the following:		N/A
	<ul style="list-style-type: none"> ▪ the test current may be reduced to any convenient value greater than 10 A sufficient to allow measurement or calculation of the impedance of the protective bonding means: 		N/A
	<ul style="list-style-type: none"> ▪ the test duration may be reduced to no less than 2 s 		N/A
	For equipment subject to the type test in 7.3.6.3.3.1a), the impedance during the routine test shall not exceed 0,1Ω.		N/A
	For equipment subject to the type test in 7.3.6.3.3.1b) the impedance during the routine test shall not exceed 2,5 V divided by the test current required by 7.3.6.3.3.1b).		N/A
7.3.6.3.5	External protective earthing conductor	See below	P
	A protective earthing conductor shall be connected at all times when power is supplied to PCE of protective class I. Unless local wiring regulations state otherwise, the protective earthing conductor cross-sectional area shall be determined from Table 11 or by calculation according to IEC 60364-5-54.	The protective earthing conductor is fixed permanently and the minimum cross-sectional area is 4mm ² for cable of phase and protective earthing. Only qualified personnel can install the protective earthing.	P
	If the external protective earthing conductor is routed through a plug and socket or similar means of disconnection, it shall not be possible to disconnect it unless power is simultaneously removed from the part to be protected.	The external protection earthing conductor just be removed when the power line is simultaneously removed from mains.	P
	The cross-sectional area of every external protective earthing conductor which does not form part of the supply cable or cable enclosure shall, in any case, be not less than:		N/A
	<ul style="list-style-type: none"> ▪ 2,5 mm² if mechanical protection is provided; 		N/A



IEC/EN 62109-1, IEC/EN 62109-2			
Clause	Requirement – Test	Result – Remark	Verdict
	<ul style="list-style-type: none"> ▪ 4 mm² if mechanical protection is not provided. 	External a minimum cross-sectional area is 4mm ² conductors for PV array and AC side of protective earthing, and 300mm ² conductors for Battery of protective earthing. The explanations are provided in the manual.	P
	For cord-connected equipment, provisions shall be made so that the external protective earthing conductor in the cord shall, in the case of failure of the strain-relief mechanism, be the last conductor to be interrupted.		N/A
7.3.6.3.6	Means of connection for the external protective earthing conductor	External protective earthing conductors connect to the enclosure body.	P
7.3.6.3.6.1	General		P
	<p>The means of connection for the external protective earthing conductor shall be located near the terminals for the respective live conductors. The means of connections shall be corrosion-resistant and shall be suitable for the connection of cables according to 7.3.6.3.5.</p> <p>The means of connection for the protective earthing conductor shall not be used as a part of the mechanical assembly of the equipment or for other connections.</p> <p>A separate means of connection shall be provided for each external protective earthing conductor. Connection and bonding points shall be so designed that their current-carrying capacity is not impaired by mechanical, chemical, or electrochemical influences. Where enclosures and/or conductors of aluminium or aluminium alloys are used, particular attention should be given to the problems of electrolytic corrosion.</p>	Considered	P
	The means of connection for the protective earthing conductor shall be permanently marked with:		P
	<ul style="list-style-type: none"> • symbol 7 of Annex C; or 		P
	<ul style="list-style-type: none"> • the colour coding green-yellow 		P
	Marking shall not be done on easily changeable parts such as screws.		P
7.3.6.3.7	Touch current in case of failure of the protective earthing conductor	See below	P
	The requirements of this sub-clause shall be satisfied to maintain safety in case of damage to or disconnection of the protective earthing conductor.		P
	For pluggable equipment type A, the touch current measured in accordance with 7.5.4 shall not exceed 3,5 mA a.c. or mA d.c.		N/A



IEC/EN 62109-1, IEC/EN 62109-2			
Clause	Requirement – Test	Result – Remark	Verdict
	For all other PCE, one or more of the following measure shall be applied, unless the touch current measured in accordance with 7.5.4 using the test network of IEC 60990 test figure 4 shall not exceed 3,5 mA a.c. or 10 mA d.c.	Living part and com. Port: 0.16 mA Live part and metal enclosure: 2.05mA	P
	a) Permanently connected wiring, and:		N/A
	<ul style="list-style-type: none"> a cross-section of the protective earthing conductor of at least 10 mm² Cu or 16 mm² Al; or 		N/A
	<ul style="list-style-type: none"> automatic disconnection of the supply in case of discontinuity of the protective earthing conductor; or 		N/A
	<ul style="list-style-type: none"> provision of an additional terminal for a second protective earthing conductor of the same cross-sectional area as the original protective earthing conductor and installation instruction requiring a second protective earthing conductor to be installed or 		N/A
	b) Connection with an industrial connector according to IEC 60309 and a minimum protective earthing conductor cross-section of 2,5 mm ² as part of a multi-conductor power cable. Adequate strain relief shall be provided.		N/A
	In addition, the caution symbol 15 of Annex C shall be fixed to the product and the installation manual shall provide details of the protective earthing measures required in the installation as required in 5.3.2.		N/A
	When it is intended and allowed to connect two or more PCEs in parallel using one common PE conductor, the above touch current requirements apply to the maximum number of the PCEs to be connected in parallel, unless one of the measures in a)		N/A
	or b) above is used. The maximum number of parallel PCEs is used in the testing and has to be stated in the installation manual.		N/A
7.3.6.4	Protective Class II – Double or Reinforced Insulation	See below	P
	Equipment or parts of equipment designed for protective class II shall have insulation between live parts and accessible surfaces in accordance with 7.3.4.3. The following requirements also apply:	Accessible communication circuits and hazardous live parts were separated by reinforced insulation.	P



IEC/EN 62109-1, IEC/EN 62109-2			
Clause	Requirement – Test	Result – Remark	Verdict
	<ul style="list-style-type: none"> equipment designed to protective class II shall not have means of connection for the external protective earthing conductor. However this does not apply if the external protective earthing conductor is passed through the equipment to equipment series-connected beyond it. In the latter event, the external protective earthing conductor and its means for connection shall be insulated with basic insulation from the accessible surface of the equipment and from circuits that employ protective separation, extra-low voltage, protective impedance and limited discharging energy, according to 7.3.5. This basic insulation shall correspond to the rated voltage of the series-connected equipment; 		P
	<ul style="list-style-type: none"> metal-encased equipment of protective class II may have provision on its enclosure for the connection of an equipotential bonding conductor; 		N/A
	<ul style="list-style-type: none"> equipment of protective class II may have provision for the connection of an earthing conductor for functional reasons or for damping of overvoltages; it shall, however, be insulated as though it is a live part; 		N/A
	<ul style="list-style-type: none"> equipment employing protective class II shall be marked according to 5.1.8. 		N/A
7.3.7	Insulation Including Clearance and Creepage Distance		P
7.3.7.1	General	See below	P
	This subclause gives minimum requirements for insulation, based on the principles of IEC 60664.	Considered	P
	Manufacturing tolerances shall be taken into account during measurement of creepage, clearance, and insulation distance in the PCE.	Considered	P
	Insulation shall be selected after consideration of the following influences:	Considered	P
	<ul style="list-style-type: none"> pollution degree 	PD3	P
	<ul style="list-style-type: none"> overvoltage category 	The mains circuits: OVC III The PV Array and battery circuits: OVC II	P
	<ul style="list-style-type: none"> supply earthing system 	TN system	P
	<ul style="list-style-type: none"> insulation voltage 	Considered	P
	<ul style="list-style-type: none"> location of insulation 	Considered	P
	<ul style="list-style-type: none"> type of insulation 	Considered	P
	Compliance of insulation, creepage distances, and clearance distances, shall be verified by measurement or visual inspection, and the tests of 7.5.	Considered	P



IEC/EN 62109-1, IEC/EN 62109-2			
Clause	Requirement – Test	Result – Remark	Verdict
7.3.7.1.1	Pollution degree		P
	Insulation, especially when provided by clearances and creepage distances, is affected by pollution that occurs during the expected lifetime of the PCE. The pollution degree rating of the PCE or section of the PCE to be used in judging the requirements of this section shall be the pollution degree determined according to 6.1 and 6.2.	PD3	P
7.3.7.1.2	Overvoltage category and Impulse withstand voltage rating		P
	The concept of overvoltage categories is applied to each separate circuit in the PCE, including mains circuits, PV circuits, and other circuits, whether connected to or isolated from the mains and PV circuits, as follows:		P
	a) For equipment or circuits energized from the mains, four categories are considered:		P
	<ul style="list-style-type: none"> category IV applies to equipment permanently connected at the origin of an installation(upstream of the main distribution board). Examples are electricity meters, primary overcurrent protection equipment and other equipment connected directly to outdoor open lines 		N/A
	<ul style="list-style-type: none"> category III applies to fixed equipment downstream of, and including, the main distribution board. Examples are switchgear and other equipment in an industrial installation; 		P
	<ul style="list-style-type: none"> category II applies to equipment not permanently connected to the installation. Examples are appliances, portable tools and other plug-connected equipment; 		N/A
	<ul style="list-style-type: none"> category I applies to equipment connected to a circuit where measures have been taken to reduce transient overvoltages to a low level. 		N/A
	Impulse withstand voltage ratings for the mains circuit are assigned based on the above OVC and on the mains system voltage, as in 7.3.7.1.4.	See clause 7.3.7.1.4.	P
	b) For PV circuits in general, Overvoltage Category II is assumed, and impulse withstand voltage ratings for the PV circuit are assigned based on the PV system voltage as in 7.3.7.1.4, but the minimum impulse voltage to be used is 2 500 V.	See clause 7.3.7.1.4.	P
	c) For PCE with galvanic isolation between the mains and PV circuits, the impulse voltage withstand ratings of the mains and PV circuits are determined as in a) and b) above, and then the effect of reduction of OVC across the isolation is evaluated as follows:	No-isolation inverter.	N/A



IEC/EN 62109-1, IEC/EN 62109-2			
Clause	Requirement – Test	Result – Remark	Verdict
	– The magnitude of impulses from the mains circuit on the PV circuit is determined by reducing the OVC of the mains circuit by one level, and determining the resulting impulse voltage withstand rating based on mains system voltage.		N/A
	– The rating to be used on the PV circuit is the higher of the value in b) and the value calculated above.		N/A
	– The magnitude of impulses from the PV circuit on the mains circuit is determined by reducing the OVC of the PV circuit by one level, and determining the resulting impulse voltage withstand rating based on PV system voltage.		N/A
	– The rating to be used on the mains circuit is the higher of the value in a) and the value calculated above.		N/A
	d) For PCE not providing galvanic isolation between the mains and PV circuits, the impulse withstand voltage ratings of the mains and PV circuits are determined as in a) and b) above, and the higher of the two impulse withstand voltage ratings is used for the entire combined circuit. For circuits connected to the combined circuit without galvanic isolation, the impulse withstand voltage rating of the combined circuit applies.	The higher impulse withstand voltage ratings between the mains, battery circuits and PV circuits were used for the entire combined circuit.	P
	e) For other circuits the impulse withstand voltage rating is the most severe rating determined by the relationship of the circuit under consideration to the PV and mains circuits, according to the following:	Considered.	P
	<ul style="list-style-type: none"> for circuits connected to the mains without galvanic isolation, the impulse withstand voltage rating of the mains circuit applies; 		P
	<ul style="list-style-type: none"> for circuits connected to the PV circuit without galvanic isolation, the impulse withstand voltage rating of the PV circuit applies; 		P
	<ul style="list-style-type: none"> where isolation is provided by means of isolation transformers, optocouplers, or similar galvanic isolation devices, between a considered circuit and an adjacent mains or PV circuit, the impulse withstand voltage rating of the considered circuit is reduced by one level from that of the adjacent circuit; if more than one adjacent circuit is involved, the highest resulting impulse withstand voltage rating applies. 		P



IEC/EN 62109-1, IEC/EN 62109-2			
Clause	Requirement – Test	Result – Remark	Verdict
	f) The overvoltage categories determined as above apply from circuits to earth. The overvoltage category that applies to functional insulation within each circuit is one category lower (less severe) than the overvoltage category that applies from the circuit to earth.	Considered	P
	g) Application of means to reduce impulse voltages: For basic and functional insulation, if transient reduction means are provided which reduce impulses to lower values, insulation may be designed for the reduced impulse levels. The reduced values to be used are the highest impulses occurring in the testing of 7.5.1.	No such parts.	N/A
	If such devices are used to reduce the values for design of Basic insulation, and the devices can be damaged by overvoltages or repeated impulses, thus decreasing their ability to reduce impulses, they shall be monitored and an indication of their status provided.		N/A
7.3.7.1.3	Supply earthing systems		P
	Three basic types of earthing system are described in IEC 60364-1. They are:	See below.	P
	<ul style="list-style-type: none"> TN system: has one point directly earthed, the accessible conductive parts of the installation being connected to that point by protective conductors. Three types of TN systems, TN-C, TN-S and TN-C-S, are defined according to the arrangement of the neutral and protective conductor. 	Considered	P
	<ul style="list-style-type: none"> TT system: has one point directly earthed, the accessible conductive parts of the installation being connected to earth electrodes electrically independent of the earth electrodes of the power system; 		N/A
	<ul style="list-style-type: none"> IT system: has all live parts isolated from earth or one point connected to earth through an impedance, the accessible conductive parts of the installation being earthed independently or collectively to the earthing system. 		N/A
7.3.7.1.4	Insulation voltages		P
	Table 12 makes use of the circuit system voltage and overvoltage category to define the impulse withstand voltage and the temporary overvoltage.	Considered	P
7.3.7.2	Insulation between a circuit and its surroundings	Considered	P
7.3.7.2.1	Basic, supplementary, and reinforced insulation between a circuit and its surroundings shall be designed according to: the impulse voltage; or the temporary overvoltage; or the working voltage of the circuit. System voltage in column 1 is:	Considered	P



IEC/EN 62109-1, IEC/EN 62109-2			
Clause	Requirement – Test	Result – Remark	Verdict
	<ul style="list-style-type: none"> in TN and TT systems: the r.m.s. value of the rated voltage between a phase and earth; 		P
	<ul style="list-style-type: none"> in three-phase IT systems: 		N/A
	<ul style="list-style-type: none"> for determination of impulse voltage, the r.m.s. value of the rated voltage between a phase and an artificial neutral point (an imaginary junction of equal impedances from each phase); 		N/A
	<ul style="list-style-type: none"> for determination of temporary overvoltage, the r.m.s. value of the rated voltage between phases; 		N/A
	<ul style="list-style-type: none"> In single-phase IT systems: the r.m.s. value of the rated voltage between phase conductors. 		N/A
7.3.7.2.2	Clearances and solid insulation between circuits connected directly to the mains and their surroundings shall be designed according to the impulse voltage, temporary overvoltage, or working voltage, whichever gives the most severe requirement.	Considered	N/A
7.3.7.2.3	Circuits other than mains circuits		P
	Clearances and solid insulation between circuits other than the mains and their surroundings shall be designed according to impulse voltage and recurring peak voltage, according to the following:		P
	<ul style="list-style-type: none"> the system voltage is <ul style="list-style-type: none"> for PV circuits, the max rated PV open circuit voltage; for other circuits, the working voltage; 		P
	<ul style="list-style-type: none"> the impulse voltage is determined from Table 12, using the system voltage above and according to 7.3.7.1.2; 		P
	<ul style="list-style-type: none"> the working voltage or the impulse voltage, whichever gives the more severe requirement, determines the design of the clearances and solid insulation. 		P
7.3.7.2.4	Insulation between two circuits shall be designed according to the following: a) for clearances and insulation, the requirements are determined by the circuit having the higher impulse voltages; b) for creepages, r.m.s. working voltage across the insulation determines the requirements.		P
7.3.7.3	Functional insulation is permitted, the voltage used for insulation requirements is determined.		P
7.3.7.4	Clearance distances		P
7.3.7.4.1	Table 13 defines the minimum clearance distances required to provide functional, basic, or supplementary insulation.	Considered	P



IEC/EN 62109-1, IEC/EN 62109-2			
Clause	Requirement – Test	Result – Remark	Verdict
	To determine clearances for reinforced insulation from Table 13, the value corresponding to the next higher impulse voltage, or 1,6 times the temporary overvoltage, or 1,6 times the working voltage shall be used, whichever results in the most severe requirement.	See appended table 7.3.7	P
7.3.7.4.2	Electric field homogeneity	Considered	P
	Homogeneous electric field distribution within impulse voltage is equal to or greater than 6000V circuits.		P
7.3.7.4.3	Clearance to conductive enclosures		P
	The clearance between any non-insulated live part and the walls of a metal enclosure shall be in accordance with 7.3.7.4.1 following the deformation tests of 13.7.	Considered	P
	If the design clearance is at least 12,7 mm and the clearance required by 7.3.7.4.1 does not exceed 8 mm, the deformation tests may be omitted.	See clause 13.7.2	P
7.3.7.5	Creepage distances		P
7.3.7.5.1	General	See below.	P
	Creepage distances shall be verified by measurement or inspection, according to Table 14. For reinforced insulation, the distances in Table 14 shall be doubled.	Considered	P
7.3.7.5.2	Voltage		P
	Table 14 is the r.m.s. value of the working voltage across the creepage distance. Interpolation is permitted.	See appended Table 7.3.7	P
7.3.7.5.3	Materials		P
	Insulating materials are classified into four groups corresponding to their comparative tracking index (CTI) when tested according to 6.2 of IEC 60112 <ul style="list-style-type: none"> • Insulating material group I CTI ≥ 600; • Insulating material group II 600 CTI ≥ 400; • Insulating material group IIIa 400 CTI ≥ 175; • Insulating material group IIIb 175 CTI ≥ 100. Creepage distances on printed wiring boards (PWBs) exposed to pollution degree 3 environmental conditions shall be determined based on Table 14 Pollution degree 3 under “Other insulators”.	Considered	P
	If the creepage distance is ribbed, then the creepage distance of insulating material of group I may be applied when using insulating material of group II and the creepage distance of insulating material of group II may be applied when using insulating material of group III.		N/A



IEC/EN 62109-1, IEC/EN 62109-2			
Clause	Requirement – Test	Result – Remark	Verdict
	Except at pollution degree 1 the ribs shall be 2 mm high at least. The spacing of the ribs shall equal or exceed the dimension 'X' in Annex A Table A.1.	Considered	P
	For inorganic insulating materials, for example glass or ceramic, which do not track, the creepage distance may equal the associated clearance, as determined from Table 13.	Considered	P
7.3.7.6	Coating	No such parts.	N/A
	A coating may be used to provide insulation, to protect a surface against pollution, and to allow a reduction in creepage and clearance distances		N/A
7.3.7.7	PWB spacings for functional insulation		P
	Functional insulation on a PWB which do not comply with 7.3.7.4 and 7.3.7.5 are permitted when all the following: <ul style="list-style-type: none"> the PWB has flammability rating of V-0 (see IEC 60695-11-10); and the PWB base material has a minimum CTI of 175; and the equipment complies with the PWB short-circuit test (see 4.4.4.14). Working voltages less than 80 V (r.m.s.) or 110 V (recurring peak) are covered with a suitable coating. The coating is not required to be tested.	Considered	P
7.3.7.8	Solid insulation		P
7.3.7.8.1	General	See below	P
	Materials selected for solid insulation shall be able to withstand the stresses occurring in the application. These include mechanical, electrical, thermal and climatic stresses which are to be expected in normal use. Insulation materials shall also be resistant to ageing during the expected lifetime of the PCE.	Considered	P
	Tests shall be performed on components and subassemblies using solid insulation, in order to ensure that the insulation performance has not been compromised by the design or manufacturing process.	Considered	P
	Components that comply with a relevant component standard that provide equivalent requirements to those of this standard do not require separate evaluation. Assemblies containing such components shall be tested according to the requirements of this standard.	Considered	P
7.3.7.8.2	Requirements for electrical withstand capability of solid insulation		P
7.3.7.8.2.1	Basic, supplemental, reinforced, and double insulation	See below	P



IEC/EN 62109-1, IEC/EN 62109-2			
Clause	Requirement – Test	Result – Remark	Verdict
	Solid insulation shall withstand the applicable impulse withstand voltage test according to 7.5.1 and the a.c. or d.c. voltage test according to 7.5.2. In addition, double and reinforced insulation shall withstand the partial discharge test according to 7.5.3, if the recurring peak working voltage across the insulation is greater than 700 V and the voltage stress on the insulation is greater than 1 kV/mm.	See clause 7.5.1, 7.5.2 and 7.5.3.	P
7.3.7.8.2.2	Functional insulation		P
	Functional insulation shall comply with the requirements of 7.3.7.3. Testing is not required.	Considered	P
7.3.7.8.3	Thin sheet or tape material		P
7.3.7.8.3.1	General		P
	Insulation consisting of thin (less than 0,7 mm) sheet or tape materials is permitted, provided that it is protected from damage and is not subject to mechanical stress under normal use.	The transformer primary and secondary windings were separated by thin insulation sheet.	P
	Thin sheet or tape material shall comply with the requirements for solid insulation in 7.3.7.8.1 and with 7.3.7.8.3.2 or 7.3.7.8.3.3 as applicable.		P
7.3.7.8.3.2	Material thickness not less than 0,2 mm		P
	<ul style="list-style-type: none">Basic or supplementary insulation shall consist of at least one layer of material, and shall meet the impulse and a.c. or d.c. voltage test requirements of 7.3.7.8.2.1 for basic or supplementary insulation.		P
	<ul style="list-style-type: none">Double insulation shall consist of at least two layers of material. Each layer shall meet the impulse and a.c. or d.c. voltage test requirements of 7.3.7.8.2.1 for basic insulation, and the partial discharge requirements of 7.3.7.8.2.1. The two or more layers together shall meet the impulse and a.c. or d.c. voltage test requirements of 7.3.7.8.2.1 for double insulation.		P
	<ul style="list-style-type: none">Reinforced insulation shall consist of a single layer of material, which will meet the impulse, a.c. or d.c. voltage, and partial discharge test requirements 7.3.7.8.2.1 for reinforced insulation.		P
7.3.7.8.3.3	Material thickness less than 0,2 mm		P
	<ul style="list-style-type: none">Basic or supplementary insulation shall consist of at least one layer of material, and shall meet the impulse and a.c. or d.c. voltage test requirements of 7.3.7.8.2.1 for basic or supplementary insulation.		P



IEC/EN 62109-1, IEC/EN 62109-2			
Clause	Requirement – Test	Result – Remark	Verdict
	<ul style="list-style-type: none"> Double insulation shall consist of at least three layers of material. Each layer shall meet the impulse and a.c. or d.c. voltage test requirements of 7.3.7.8.2.1 for basic insulation. Any two layers together shall meet the impulse, a.c. or d.c. voltage, and partial discharge test requirements of 7.3.7.8.2.1 for double insulation. 		P
	<ul style="list-style-type: none"> Reinforced insulation consisting of a single layer of material less than 0,2 mm thick is not permitted. 		P
7.3.7.8.3.4	Compliance		P
	Compliance is checked by the tests described in 7.5.1 to 7.5.3 applied according to 7.3.7.8.2. When a component or sub-assembly makes use of thin sheet insulating materials, it is permitted to perform the tests on the component rather than on the material.	See clause 7.5.1, 7.5.2 and 7.5.3.	P
7.3.7.8.4	Printed wiring boards (PWBs)	Considered.	P
7.3.7.8.4.1	General		P
	Insulation between conductor layers in PWBs, shall meet the requirements for solid insulation in 7.3.7.8. For the inner layers of multi-layer PWBs, the insulation between adjacent tracks on the same layer shall be treated as either:		P
	<ul style="list-style-type: none"> a creepage distance for pollution degree 1 and a clearance as in air (see Annex A, figure A.13); or 		P
	<ul style="list-style-type: none"> as solid insulation, in which case it shall meet the requirements of 7.3.7.8. 		P
7.3.7.8.4.2	Use of coating materials	No coating materials.	N/A
	A coating material used to provide a microenvironment or to provide functional, basic, supplementary and reinforced insulation shall meet the requirement as specified below.		N/A
	<ul style="list-style-type: none"> Type 1 protection improves the microenvironment (PollutionDegree) of the parts under protection. The clearance and creepage distance of Table 13 and Table 14 for pollution degree 1 apply under the protection. 		N/A
	<ul style="list-style-type: none"> Type 2 protection is considered to be similar to solid insulation. Under the protection, the requirements for solid insulation specified in 7.3.7.8 are applicable and spacings shall not be less than those specified in Table 1 of IEC 60664-3. 		N/A
	The coating material used to provide Type 1 and Type 2 protection shall be checked by a type test on representative PWB's, conducted according to IEC 60664-3 Clause 5.		N/A
7.3.7.8.5	Wound components		P



IEC/EN 62109-1, IEC/EN 62109-2			
Clause	Requirement – Test	Result – Remark	Verdict
	Varnish or enamel insulation of wires shall not be used for basic, supplementary, double or reinforced insulation.	Considered.	P
	The component itself shall pass the requirements given in 7.3.7.8.1 and 7.3.7.8.2. If the component has reinforced or double insulation, the voltage test in 7.5.2 shall be performed as a routine test.	Considered.	P
7.3.7.8.6	Potting materials		N/A
	A potting material may be used to provide solid insulation or to act as a coating to protect against pollution. It shall comply with the requirements of 7.3.7.8.1 and 7.3.7.8.2. or the requirements for Type 1 protection in 7.3.7.8.4.2 apply.		N/A
7.3.7.9	Insulation requirements above 30 kHz	Considered.	P
7.3.8	Residual Current-operated protective (RCD) or monitoring (RCM) device compatibility	The RCD is built-in type within the PCE.	P
	RCD and RCM are used to provide protection against insulation faults in some domestic and industrial installations, additional to that provided by the installed equipment.		P
7.3.9	Capacitor discharge	See below.	P
7.3.9.1	Operator access area		P
	Equipment shall be so designed that there is no risk of electric shock in operator access areas from charge stored on capacitors after disconnection of the PCE.	The operator is instructed to the installation shall be performed by qualified technician. The pins of connector cannot be touched by test finger due to the design protection.	P
7.3.9.2	Service access areas		P
	Capacitors located behind panels that are removable for servicing, installation, or disconnection shall present no risk of electric shock or energy hazard from charge stored on capacitors after disconnection of the PCE.	The symbol 21 of Annex C with 5min was provided on the label.	P
7.3.10 of IEC 62109-2	Additional requirements for stand-alone inverters		P
	Depending on the supply earthing system that a stand-alone inverter is intended to be used with or to create, the output circuit may be required to have one circuit conductor bonded to earth to create a grounded conductor and an earthed system.		P
	The means used to bond the grounded conductor to protective earth may be provided within the inverter or as part of the installation. If not provided integral to the inverter, the required means shall be described in the installation instructions as per 5.3.2.8.	External isolated transformer provided Neutral bonded to earthing and installed on field, which required in user manual	P



IEC/EN 62109-1, IEC/EN 62109-2			
Clause	Requirement – Test	Result – Remark	Verdict
	The means used to bond the grounded conductor to protective earth shall comply with the requirements for protective bonding in Part 1, except that if the bond can only ever carry fault currents in stand-alone mode, the maximum current for the bond is determined by the inverter maximum output fault current.		P
	Output circuit bonding arrangements shall ensure that in any mode of operation, the system only has the grounded circuit conductor bonded to earth in one place at a time. Switching arrangements may be used, in which case the switching device used is to be subjected to the bond impedance test along with the rest of the bonding path.		N/A
	Inverters intended to have a circuit conductor bonded to earth shall not impose any normal current on the bond except for leakage current.		P
	Outputs that are intentionally floating with no circuit conductor bonded to ground, must not have any voltages with respect to ground that are a shock hazard in accordance with Clause 7 of Parts 1 and 2. The documentation for the inverter shall indicate that the output is floating as per 5.3.2.8.		N/A
7.3.11 of IEC 62109-2	Functionally grounded arrays	No such parts.	N/A
	All PV conductors in a functionally grounded array shall be treated as being live parts with respect to protection against electric shock.		N/A
7.4	Protection against energy hazards		P
7.4.1	Determination of hazardous energy level		P
	A hazardous energy level is considered to exist if	See below	P
	a) The voltage is 2 V or more, and power available after 60 s exceeds 240 VA.	Considered	P
	b) The stored energy in a capacitor is at a voltage. U of 2 V or more, and the stored energy. E, calculated from the following equation, exceeds 20J: $E = 0,5 CU^2$	Considered	P
7.4.2	Operator Access Areas	See below	P
	Equipment shall be so designed that there is no risk of energy hazard in operator access areas from accessible circuits.	All hazardous energy parts were enclosed within earthed metal enclosure.	P
7.4.3	Services Access Areas		P
	Energy storage devices located behind panels that are removable for servicing, installation or disconnection shall present no risk of electric energy hazard from charge stored after disconnection of the PCE.	See below	P
	Energy storage devices within a PCE shall be discharged to an energy level less than 20 J, as in 7.4.1, within 10 s after the removal	The symbol 21 of Annex C was provided on the label.	P



IEC/EN 62109-1, IEC/EN 62109-2			
Clause	Requirement – Test	Result – Remark	Verdict
7.5	Electrical test related to shock hazard		P
7.5.1	Impulse voltage test (type test)		P
	The impulse voltage test is performed with voltage having a 1.2/50µs waveform. Test is performed using the impulse withstand voltage listed in Table 16.	See below	P
	The impulse voltage test and is successfully passed if no puncture, flashover, or sparkover occurs.	See appended Table 7.5	P
7.5.2	Dielectric strength test		P
7.5.2.2	The values of the test voltage are determined from column 2 or 3 of Table 17 or Table 18.	See below	P
	The voltage test shall be performed with a sinusoidal voltage at 50 Hz or 60 Hz. If the circuit contains capacitors the test may be performed with a d.c. voltage of a value equal to the peak value of the specified a.c. voltage.	See appended Table 7.5	P
7.5.2.3	Humidity pre-conditioning		P
	For type tests on PCE for which wet locations requirements apply, according to 6.1, the humidity pre-conditioning of 4.5 shall be performed immediately prior to the voltage test.	Considered	P
7.5.2.4	Performing the voltage test.		P
	a) between accessible conductive part and each circuit sequentially.	Considered	P
	b) Test between each considered circuit sequentially and the other adjacent circuits connected together.	Considered	P
	c) Test between DVC A circuit and each adjacent circuit sequentially	Considered	P
	The tests shall be performed with the PCE fully assembled, and all covers in place and all doors of the enclosure closed.		P
	Wherever practicable, individual components forming part of the insulation under test, for example interference suppression capacitors, should not be disconnected or bridged before the test.		P
	Where the PCE is covered totally or partly by a non-conductive accessible surface, a conductive foil to which the test voltage is applied shall be wrapped around this surface for testing.		P
7.5.2.5	Duration of the a.c. or d.c. voltage test		P
	The duration of the test shall be at least 60 s at full voltage for the type test and 1 s for the routine test.	Considered	P
7.5.2.6	Verification of the a.c. or d.c. voltage test		P
	The test is successfully passed if no electrical breakdown occurs and there is no abnormal current flow during the test.	Considered	P
7.5.3	Partial discharge test		N/A



IEC/EN 62109-1, IEC/EN 62109-2			
Clause	Requirement – Test	Result – Remark	Verdict
	the partial discharge test shall confirm that the solid insulation used within devices applied for protective separation of electrical circuits remains partialdischarge- free within the specified voltage range (see Table 19).		N/A
7.5.4	Touch current measurement (type test)		P
	The touch current shall be measured if required by 7.3.6.3.7 and shall not be greater than 3.5 mA a.c. or 10 mA d.c. or special measures of protection as given in 7.3.6.3.7 are required.	See 7.3.6.3.7	P
	For type tests on PCE for which wet locations requirements apply according to 6.1, the humidity pre-conditioning of 4.5 shall be performed immediately prior to the touch current test.	See 7.3.6.3.7	P
7.5.5	Equipment with multiple sources of supply		N/A
	Hazards, within the meaning of this standard, shall not be present under normal or single fault conditions due to the presence of multiple sources of supply. Information shall be provided with the equipment indicating the presence of multiple sources of supply and giving disconnection procedures.		N/A
8	PROTECTION AGAINST MECHANICAL HAZARDS		P
8.1	General		P
	Operation shall not lead to a mechanical HAZARD in NORMAL CONDITION or SINGLE FAULT CONDITION. Edges, projections, corners, openings, guards, handles and the like, that are accessible to the operator shall be smooth and rounded so as not to cause injury during normal use of the equipment.	No mechanical hazards under the normal or single fault condition.	P
	Conformity is checked as specified in 8.2 to 8.6.		P
8.2	Moving parts		P
	Moving parts shall not be able to crush, cut or pierce parts of the body of an OPERATOR likely to contact them, nor severely pinch the OPERATOR's skin. Hazardous moving parts of equipment, that is moving parts which have the potential to cause injury, shall be so arranged, enclosed or guarded as to provide adequate protection against the risk of personal injury.	Considered.	P
8.2.1	Protection of service persons	No mechanical hazards for service persons.	P
	Protection shall be provided such that unintentional contact with hazardous moving parts is unlikely during servicing operations. If a guard over a hazardous moving part may need to be removed for servicing, the marking of symbol 15 of Table D-1 shall be applied on or near the guard.		P
8.3	Stability		N/A
	Equipment and assemblies of equipment not secured to the building structure before operation shall be physically stable in NORMAL USE.	PCE for wall mounting.	N/A



IEC/EN 62109-1, IEC/EN 62109-2			
Clause	Requirement – Test	Result – Remark	Verdict
8.4	Provisions for lifting and carrying		N/A
	If carrying handles or grips are fitted to, or supplied with, the equipment, they shall be capable of withstanding a force of four times the weight of the equipment.		N/A
	Equipment or parts having a mass of 18 kg or more shall be provided with a means for lifting and carrying or directions shall be given in the manufacturer's documentation.		N/A
8.5	Wall mounting		P
	Mounting brackets on equipment intended to be mounted on a wall or ceiling shall withstand a force of four times the weight of the equipment.	No any damaged after testing.	P
8.6	Expelled parts		N/A
	Equipment shall contain or limit the energy of parts that could cause a HAZARD if expelled in the event of a fault.	No such parts.	N/A
9	PROTECTION AGAINST FIRE HAZARDS		P
9.1	Resistance to fire		P
	This subclause specifies requirements intended to reduce the risk of ignition and the spread of flame, both within the equipment and to the outside, by the appropriate use of materials and components and by suitable construction.	PCE employed with metal enclosure reduce the risk of ignition and the spread of flame.	P
9.1.1	Reducing the risk of ignition and spread of flame		P
	For equipment or a portion of equipment, there are two alternative methods of providing protection against ignition and spread of flame that could affect materials, wiring, wound components and electronic components such as integrated circuits, transistors, thyristors, diodes, resistors and capacitors.	Method 1 is used.	P
9.1.2	Conditions for a fire enclosure		P
	A FIRE ENCLOSURE is required for equipment or parts of equipment for which Method 2 is not fully applied and complied with.	Fire enclosure is used.	P
9.1.2.1	Parts requiring a fire enclosure		P
	Except where Method 2 is used, or as permitted in 9.1.2.2, the following are considered to have a risk of ignition and, therefore, require a FIRE ENCLOSURE:	Considered.	P
	– components in PRIMARY CIRCUITS	Considered.	P
	– components in SECONDARY CIRCUITS supplied by power sources which exceed the limits for a LIMITED POWER SOURCE as specified in 9.2;	Considered.	P
	– components in SECONDARY CIRCUITS supplied by a LIMITED POWER SOURCE as specified in 9.2, but not mounted on a material of FLAMMABILITY CLASS V-1;	No such devices.	N/A



IEC/EN 62109-1, IEC/EN 62109-2			
Clause	Requirement – Test	Result – Remark	Verdict
	– components within a power supply unit or assembly having a limited power output complying with the criteria for a LIMITED POWER SOURCE as specified in 9.2, including overcurrent protective devices, limiting impedances, regulating networks and wiring, up to the point where the LIMITED POWER SOURCE output criteria are met;	No such devices.	N/A
	– components having unenclosed arcing parts, such as open switch and relay contacts and commutators, in a circuit at HAZARDOUS VOLTAGE or at a HAZARDOUS ENERGY LEVEL; and	No such devices.	N/A
	– insulated wiring, except as permitted in 9.1.2.2.	Considered.	P
9.1.2.2	Parts not requiring a fire enclosure	Component within fire enclosure.	N/A
9.1.3	Materials requirements for protection against fire hazard		P
9.1.3.1	General		P
	ENCLOSURES, components and other parts shall be so constructed, or shall make use of such materials, that the propagation of fire is limited.	Considered.	P
9.1.3.2	Materials for fire enclosures		P
	If an enclosure material is not classified as specified below, a test may be performed on the final enclosure or part of the enclosure, in which case the material shall additionally be subjected to periodic SAMPLE testing.	PCE with metal fire enclosure.	P
9.1.3.3	Materials for components and other parts outside fire enclosures	Considered.	P
	Except as otherwise noted below, materials for components and other parts (including MECHANICAL ENCLOSURES, ELECTRICAL ENCLOSURES and DECORATIVE PARTS); located outside FIRE ENCLOSURES, shall be of FLAMMABILITY CLASS HB.	Considered.	P
9.1.3.4	Materials for air filter assemblies		N/A
9.1.4	Openings in fire enclosures	Considered.	P
9.1.4.1	General		N/A
	For equipment that is intended to be used or installed in more than one orientation as specified in the product documentation, the following requirements apply in each orientation.	Vertical mounting only.	N/A
	These requirements are in addition to those in the following sections:		N/A
	– 7.3.4, Protection against direct contact;		N/A
	– 7.4, Protection against energy hazards;		N/A
	– 13.5, Openings in enclosures		N/A
9.1.4.2	Side openings treated as bottom openings		N/A
9.1.4.3	Openings in the bottom of a fire enclosure	PCE for use in a closure electrical operating area.	N/A



IEC/EN 62109-1, IEC/EN 62109-2			
Clause	Requirement – Test	Result – Remark	Verdict
	The bottom of a FIRE ENCLOSURE or individual barriers, shall provide protection against emission of flaming or molten material under all internal parts, including partially enclosed components or assemblies, for which Method 2 of 9.1.1 has not been fully applied and complied with.	PCE for use in a closure electrical operating area.	N/A
9.1.4.4	Equipment for use in a CLOSED ELECTRICAL OPERATING AREA	Considered.	P
	The requirements of 9.1.4.3 do not apply to FIXED EQUIPMENT intended only for use in a CLOSED ELECTRICAL OPERATING AREA and to be mounted on a concrete floor or other non-combustible surface. Such equipment shall be marked as follows:	Considered.	P
	WARNING: FIRE HAZARD SUITABLE FOR MOUNTING ON CONCRETE OR OTHER NON-COMBUSTIBLE SURFACE ONLY	Considered.	P
9.1.4.5	Doors or covers in fire enclosures	No any door or covers in fire enclosure.	N/A
9.1.4.6	Additional requirements for openings in transportable equipment		N/A
9.2	LIMITED POWER SOURCES	No LPS circuits.	N/A
9.2.1	General		N/A
9.2.2	Limited power source tests		N/A
9.3	Short-circuit and overcurrent protection		P
9.3.1	General		P
	The PCE shall not present a hazard, under short-circuit or overcurrent conditions at any port, including phase-to-phase, phase-to-earth and phase-to-neutral, and adequate information shall be provided to allow proper selection of external wiring and external protective devices.	The circumstances of short-circuit and overcurrent are protected by the circuits design. When short-circuit or overcurrent of components occurred, the PCE will shutdown and disconnect from the grid immediately.	P
9.3.2	Protection against short-circuits and overcurrents shall be provided for all input circuits, and for output circuits that do not comply with the requirements for limited power sources in 9.2, except for circuits in which no overcurrent hazard is presented by short-circuits and overloads.		N/A
9.3.3	Protective devices provided or specified shall have adequate breaking capacity to interrupt the maximum short circuit current specified for the port to which they are connected. If protection that is provided integral to the PCE for an input port is not rated for the short-circuit current of the circuit in which it is used, the installation instructions shall specify that an upstream protective device, rated for the prospective short-circuit current of that port, shall be used to provide backup protection.		N/A
9.3.4 of IEC 62109-2	Inverter backfeed current onto the array	Considered.	P



IEC/EN 62109-1, IEC/EN 62109-2			
Clause	Requirement – Test	Result – Remark	Verdict
	The backfeed current testing and documentation requirements in Part 1 apply, including but not limited to the following.	Considered.	P
	Testing shall be performed to determine the current that can flow out of the inverter PV input terminals with a fault applied on inverter or on the PV input wiring. Faults to be considered include shorting all or part of the array, and any faults in the inverter that would allow energy from another source (for example the mains or a battery) to impress currents on the PV array wiring. The current measurement is not required to include any current transients that result from applying the short circuit, if such transients result from discharging storage elements other than batteries.	No backfeed current that can flow out of the inverter PV input terminals.	P
	This inverter backfeed current value shall be provided in the installation instructions regardless of the value of the current, in accordance with Table 33.		N/A

10	PROTECTION AGAINST SONIC PRESSURE HAZARDS		P
10.1	General		P
	The equipment shall provide protection against the effect of sonic pressure. Conformity tests are carried out if the equipment is likely to cause such HAZARDS.	No sonic pressure hazards.	P
10.2	Sonic pressure and Sound level		P
10.2.1	Hazardous Noise Levels		P

11	PROTECTION AGAINST LIQUID HAZARDS		N/A
11.1	Liquid Containment, Pressure and Leakage	No liquid containment.	N/A
	The liquid containment system components shall be compatible with the liquid to be used.		N/A
	There shall be no leakage of liquid onto live parts as a result of:		N/A
	a) Normal operation, including condensation;		N/A
	b) Servicing of the equipment; or		N/A
	c) Inadvertent loosening or detachment of hoses or other cooling system parts over time.		N/A
11.2	Fluid pressure and leakage		N/A
11.2.1	Maximum pressure		N/A
11.2.2	Leakage from parts		N/A
11.2.3	Overpressure safety device		N/A
11.3	Oil and grease		N/A

12	CHEMICAL HAZARDS		N/A
12.1	General	No chemical hazards.	N/A

13	PHYSICAL REQUIREMENTS		P
13.1	Handles and manual controls		P



IEC/EN 62109-1, IEC/EN 62109-2			
Clause	Requirement – Test	Result – Remark	Verdict
	Handles, knobs, grips, levers and the like shall be reliably fixed so that they will not work loose in normal use, if this might result in a hazard. Sealing compounds and the like, other than selfhardening resins, shall not be used to prevent loosening. If handles, knobs and the like are used to indicate the position of switches or similar components, it shall not be possible to fix them in a wrong position if this might result in hazard.	DC breaker holder for manual controls.	P
13.1.1	Adjustable controls	No such devices.	N/A
13.2	Securing of parts		P
13.3	Provisions for external connections		P
13.3.1	General		P
13.3.2	Connection to an a.c. Mains supply	AC connector to an a.c. mains supply.	P
13.3.2.1	General		P
	For safe and reliable connection to a MAINS supply, equipment shall be provided with one of the following:		P
	– terminals or leads or a non-detachable power supply cord for permanent connection to the supply; or	Screw terminal for permanent connection to the supply.	P
	– a non-detachable power supply cord for connection to the supply by means of a plug		N/A
	– an appliance inlet for connection of a detachable power supply cord; or		N/A
	– a mains plug that is part of direct plug-in equipment as in 13.3.8		N/A
13.3.2.2	Permanently connected equipment	Specific and certified connectors used.	P
13.3.2.3	Appliance inlets		N/A
13.3.2.4	Power supply cord	Considered.	P
13.3.2.5	Cord anchorages and strain relief	Battery supply cord used.	P
	For equipment with a non-detachable power supply cord, a cord anchorage shall be supplied such that:		P
	– the connecting points of the cord conductors are relieved from strain; and	Considered.	P
	– the outer covering of the cord is protected from abrasion.	Considered.	P
13.3.2.6	Protection against mechanical damage		P
13.3.3	Wiring terminals for connection of external conductors	DC, AC and battery terminals for connection of external conductors.	P
13.3.3.1	Wiring terminals		P
13.3.3.2	Screw terminals		P
13.3.3.3	Wiring terminal sizes		P
13.3.3.4	Wiring terminal design		P
13.3.3.5	Grouping of wiring terminals		P
13.3.3.6	Stranded wire		P
13.3.4	Supply wiring space		P



IEC/EN 62109-1, IEC/EN 62109-2			
Clause	Requirement – Test	Result – Remark	Verdict
13.3.5	Wire bending space for wires 10 mm ² and greater		P
13.3.6	Disconnection from supply sources	The explanations are provided in the installation manual.	P
13.3.7	Connectors, plugs and sockets	The misconnection is unlikely for PVDC connectors and AC output connector.	P
13.3.8	Direct plug-in equipment	Permanently equipment.	N/A
13.4	Internal wiring and connections		P
13.4.1	General	All wires were used suitably and are fixed well to prevent mechanical damage during installation.	P
13.4.2	Routing	The wires were routed away from all parts which could abrade the insulation of wires.	P
13.4.3	Colour coding	Green/yellow wire only used for protective earthing conductor.	P
13.4.4	Splices and connections	Quick connectors were used for internal connection.	P
13.4.5	Interconnections between parts of the PCE	The communication cable only used for servicing, no any physical damage or mechanical damage likely.	P
13.5	Openings in enclosures		P
13.5.1	Top and side openings	See 9.1.4.	P
	Openings in the top and sides of ENCLOSURES shall be so located or constructed that it is unlikely that objects will enter the openings and create hazards by contacting bare conductive parts.		P
13.6	Polymeric Materials		N/A
13.6.1	General		N/A
13.6.1.1	Thermal index or capability		N/A
13.6.2	Polymers serving as enclosures or barriers preventing access to hazards		N/A
13.6.2.1	Stress relief test		N/A
13.6.3	Polymers serving as solid insulation	Considered.	P
13.6.3.1	Resistance to arcing	Considered.	P
13.6.4	UV resistance		P
	Polymeric parts of an OUTDOOR ENCLOSURE required for compliance with this standard shall be sufficiently resistance to degradation by ultra-violet (UV) radiation	The displayer panel and connection terminals could protect against UV radiation.	P
13.7	Mechanical resistance to deflection, impact, or drop		P
13.7.1	General		P
13.7.2	250-N deflection test for metal enclosures	No hazards.	P
13.7.3	7-J impact test for polymeric enclosures	No hazards.	P
13.7.4	Drop test	Not a hand-held, direct plug-in and transportable equipment.	N/A
13.8	Thickness requirements for metal enclosures		N/A
13.8.1	General	The metal enclosure complied with 13.7.	N/A
13.8.2	Cast metal		N/A



IEC/EN 62109-1, IEC/EN 62109-2			
Clause	Requirement – Test	Result – Remark	Verdict
13.8.3	Sheet metal		N/A
13.9 of IEC 62109-2	Fault indication	See below.	P
	Where this Part 2 requires the inverter to indicate a fault, both of the following shall be provided:	LCD screen or interface connected to PC as fault indication.	P
	a) a visible or audible indication, integral to the inverter, and detectable from outside the inverter, and	LCD screen shown fault information.	P
	b) an electrical or electronic indication that can be remotely accessed and used.	RS485 can be used for communication between PCE and PC.	P
	The installation instructions shall include information regarding how to properly make connections (where applicable) and use the electrical or electronic means in b) above, in accordance with 5.3.2.10.	The instructions are specified in section "Installation" of the Product manual.	P

14	COMPONENTS		P
14.1	General		P
	Where safety is involved, components shall be used in accordance with their specified RATINGS unless a specific exception is made. They shall conform to one of the following:	Considered.	P
	a) applicable safety requirements of a relevant IEC standard. Conformity with other requirements of the component standard is not required. If necessary for the application, components shall be subjected to the test of this standard, except that it is not necessary to carry out identical or equivalent tests already performed to check conformity with the component standard;	Considered.	P
	b) the requirements of this standard and, where necessary for the application, any additional applicable safety requirements of the relevant IEC component standard;	Considered.	P
	c) if there is no relevant IEC standard, the requirements of this standard;	Considered.	P
	d) applicable safety requirements of a non-IEC standard which are at least as high as those of the applicable IEC standard, provided that the component has been approved to the non-IEC standard by a recognized testing authority.	Considered.	P
	Components such as optocouplers, capacitors, transformers, and relays connected across basic, supplemental, reinforced, or double insulation shall comply with the requirements applicable for the grade of insulation being bridged, and if not previously certified to the applicable component safety standard shall be subjected to the voltage test of 7.5.2 as routine test.	Considered.	P



IEC/EN 62109-1, IEC/EN 62109-2			
Clause	Requirement – Test	Result – Remark	Verdict
14.2	Motor Overtemperature Protection		N/A
	Motors which, when stopped or prevented from starting (see 4.4.4.3), would present an electric shock HAZARD, a temperatur HAZARD, or a fire HAZARD, shall be protected by an overtemperature or thermal protection device meeting the requirements of 14.3.		N/A
14.3	Overtemperature protection devices	No such devices.	N/A
14.4	Fuse holders		N/A
14.5	MAINS voltage selecting devices	No such devices.	N/A
14.6	Printed circuit boards		P
	Printed circuit boards shall be made of material with a flammability classification of V-1 of IEC 60707 or better.	V-0 PCBs used.	P
	This requirements does not apply to thin-film flexible printed circuit boards that contain only circuits powered from limited power sources meeting the requirements of 9.2.		P
	Conformity of the flammability RATING is checked by inspection of data on the materials. Alternatively, conformity is checked by performing the V-1 tests specified in IEC 60707 on three samples of the relevant parts.		P
14.7	Circuits or components used as transient overvoltage limiting devices		P
	If control of transient overvoltage is employed in the equipment, any overvoltage limiting component or circuit shall be tested with the applicable impulse withstand voltage of Table 7-10 using the test method from 7.5.1 except 10 positive and 10 negative impulses are to be applied and may be spaced up to 1 min apart.	Considered.	P
14.8	Batteries		P
	Equipment containing batteries shall be designed to reduce the risk of fire, explosion and chemical leaks under normal conditions and after a single fault in the equipment including a fault in circuitry within the equipment battery pack.	Sealed lead acid battery, Vented battery, Gel battery and lithium battery of external battery pack (EBP) used. The detail installation and maintenance explanations are provided in the manufacturer's EBP of manual.	N/A
14.8.1	Battery Enclosure Ventilation	The detail installation and maintenance explanations are provided in the manufacturer's EBP of manual.	N/A
14.8.1.1	Ventilation requirements		N/A
14.8.1.2	Ventilation testing		N/A
14.8.1.3	Ventilation instructions		N/A
14.8.2	Battery Mounting	See below.	N/A



IEC/EN 62109-1, IEC/EN 62109-2			
Clause	Requirement – Test	Result – Remark	Verdict
	Compliance is verified by the application of the force to the battery's mounting surface. The test force is to be increased gradually so as to reach the required value in 5 to 10 s, and is to be maintained at that value for 1 min. A nonmetallic rack or tray shall be tested at the highest normal condition operating temperature.	The detail installation and maintenance explanations are provided in the manufacturer's EBP of manual.	N/A
14.8.3	Electrolyte spillage	See below.	N/A
	Battery trays and cabinets shall have an electrolyte-resistant coating.	The detail installation and maintenance explanations are provided in the manufacturer's EBP of manual.	N/A
	The ENCLOSURE or compartment housing a VENTED BATTERY shall be constructed so that spillage or leakage of the electrolyte from one battery will be contained within the ENCLOSURE and be prevented from:		N/A
	a) reaching the PCE outer surfaces that can be contacted by the USER		N/A
	b) contaminating adjacent electrical components or materials; and		N/A
	c) bridging required electrical distances		N/A
14.8.4	Battery Connections	See below.	N/A
	Reverse battery connection of the terminals shall be prevented if reverse connection could result in a hazard within the meaning of this Standard	The warning description provided in the manual. See 4.4.4.11.	N/A
14.8.5	Battery maintenance instructions	See below.	N/A
	The information and instructions listed in 5.3.4.1 shall be included in the operator manual for equipment in which battery maintenance is performed by the operator, or in the service manual if battery maintenance is to be performed by service personnel only.	The detail installation and maintenance explanations are provided in the manufacturer's EBP of manual.	N/A
14.8.6	Battery accessibility and maintainability	See below.	N/A
	Battery terminals and connectors shall be accessible for maintenance with the correct TOOLS. Batteries with liquid electrolyte, requiring maintenance shall be so located that the battery cell caps are accessible for electrolyte tests and readjusting of electrolyte levels.	The detail installation and maintenance explanations are provided in the manufacturer's EBP of manual.	N/A

15	Software and firmware performing safety functions	The software evaluated according to IEC 60730 annex H. See separated software evaluation report for detail.	P
-----------	--	---	----------

Annex B	Programmable equipment		P
B.1	Software or firmware that performs safety critical functions	The software evaluated according to IEC 60730 annex H. See separated software evaluation report for detail.	P



IEC/EN 62109-1, IEC/EN 62109-2			
Clause	Requirement – Test	Result – Remark	Verdict
B.1.1	Firmware or software that performs a critical safety function/s, such as protection from excessive temperature, over current or improper synchronization of AC sources, the failure of which can result in a risk of fire, electric shock or other hazard as specified by this standard, shall be evaluated by one of the following means.	The software evaluated according to IEC 60730 annex H. See separated software evaluation report for detail.	P
	a) All software or firmware limits or controls shall be disabled before the test to evaluate the hardware circuitry during the abnormal test condition related to the safety function, or the hardware sensor component that is monitored by the firmware or software is modified or disabled to prevent the software or firmware from reading or responding to the abnormal condition.		N/A
	b) Protective controls employing software or firmware to perform their function(s) shall be so constructed that they comply with IEC 60730-1 Annex H to address the risks identified in B.2.1. Each combination of microprocessor model, manufacturer and firmware/software version used in the production of a PCE shall be evaluated as specified in the remainder of Annex B.	The software evaluated according to IEC 60730 annex H. See separated software evaluation report for detail.	P
	Exception: For units with firmware/software that has been found to be compliant with the remainder of Annex B, subsequent firmware/software revisions may be entitled to a limited reevaluation for the revised firmware or software. The scope of the reevaluation shall be defined by the potential impact of the firmware or software revisions and the applicable portions of IEC 60730-1 Annex H shall be reapplied.		P
B.2	Evaluation of controls employing software	The software evaluated according to IEC 60730 annex H. See separated software evaluation report for detail.	P
B.2.1.1	A risk analysis shall be conducted to determine a set of risks and that the software addresses the identified risks. The risk analysis shall be conducted based on the safety requirements for the programmable component.		P
B.2.1.2	An analysis shall be conducted to identify the critical, non-critical, and supervisory parts of the software.		P
B.2.1.3	An analysis shall be conducted to identify transitions or states that can result in a risk.		P
B.2.1.4	Risks to be considered include, but are not limited to functions associated with the following:		P
	a) Temperature control, monitoring and response (i.e. coolant, internal ambient, device)		P
	b) Safety interlocks		P
	c) Synchronization between multiple AC sources		P
	d) Emergency stop of operation (including staged shutdown / sequencing)		P



IEC/EN 62109-1, IEC/EN 62109-2			
Clause	Requirement – Test	Result – Remark	Verdict
	e) Connection / disconnection – from an input source and output source		P
	f) RCD functions		P
	g) Over current protection or control		P

Annex J	Ultraviolet light conditioning test		N/A
J.1	General	Certificated plastic enclouse used.	N/A
	Samples mounted as in Clause J.2 are to be exposed to ultraviolet light by using either the apparatus in Clauses J.3 or J.4, and shall comply with the criteria in 13.6.4.		N/A
J.2	Mounting of test samples	Certificated plastic enclouse used.	N/A
	The samples are mounted vertically on the inside of the cylinder of the light exposure apparatus, with the widest portion of the sample facing the arcs. They are mounted so that they do not touch each other.		N/A
J.3	Carbon-arc light-exposure apparatus	Certificated plastic enclouse used.	N/A
	The apparatus described in ISO 4892-4, or equivalent, is used in accordance with the procedures given in ISO 4892-1 and ISO 4892-4 using a type 1 filter, with water spray.		N/A
J.4	Xenon-arc light-exposure apparatus	Certificated plastic enclouse used.	N/A
	The apparatus described in ISO 4892-2, or equivalent, is used in accordance with the procedures given in ISO 4892-1 and ISO 4892-2 using method A, with water spray.		N/A



4.2.2.6 TABLE: mains supply electrical data in normal condition						P
Type	U (V)	I (A) DC	P (W) DC	U (V)	I (A) AC	P (W) AC
PV Input mode						
HYD 6000-ES	90Vdc	7.223	646	230V/50Hz	2.936	590
HYD 6000-ES	300Vdc	20.739	6225	230V/50Hz	25.789	5954
HYD 6000-ES	360Vdc	17.274	6169	230V/50Hz	25.824	5961
HYD 6000-ES	520Vdc	12.096	6234	230V/50Hz	26.208	6014
HYD 6000-ES	580Vdc	0.528	299	230V/50Hz	1.721	265
HYD 6000-ES	90Vdc	7.087	645	230V/60Hz	2.981	590
HYD 6000-ES	300Vdc	20.653	6209	230V/60Hz	25.732	5932
HYD 6000-ES	360Vdc	17.112	6131	230V/60Hz	25.66	5926
HYD 6000-ES	520Vdc	12.020	6206	230V/60Hz	26.091	5991
HYD 6000-ES	580Vdc	0.529	301	230V/60Hz	1.830	285
Type	U (V)	I (A) DC	P (W) DC	U (V)	I (A) DC	P (W) DC
PV charging mode						
HYD 6000-ES	90Vdc	7.225	647	46Vdc	11.804	543
HYD 6000-ES	300Vdc	10.646	3208	46Vdc	64.989	2985
HYD 6000-ES	360Vdc	8.858	3174	46Vdc	64.981	2990
HYD 6000-ES	520Vdc	6.155	3197	46Vdc	64.964	2987
HYD 6000-ES	580Vdc	0.519	299	46Vdc	5.132	236
HYD 6000-ES	90Vdc	7.165	646	48Vdc	11.409	548
HYD 6000-ES	300Vdc	10.740	3212	48Vdc	62.780	3011
HYD 6000-ES	360Vdc	8.936	3214	48Vdc	63.000	3023
HYD 6000-ES	520Vdc	6.179	3215	48Vdc	62.799	3011
HYD 6000-ES	580Vdc	0.519	297	48Vdc	4.904	235
HYD 6000-ES	90Vdc	7.223	647	58Vdc	9.256	539
HYD 6000-ES	300Vdc	10.619	3191	58Vdc	51.439	2993
HYD 6000-ES	360Vdc	8.907	3214	58Vdc	51.856	3017
HYD 6000-ES	520Vdc	6.201	3217	58Vdc	52.320	3042
HYD 6000-ES	580Vdc	0.515	297	58Vdc	4.029	234
Type	U (V)	I (A) AC	P (W) AC	U (V)	I (A) DC	P (W) DC
AC charging mode						
HYD 6000-ES	207Vac	15.712	3241	46Vdc	64.924	2976
HYD 6000-ES	230Vac	14.110	3234	46Vdc	64.904	2978
HYD 6000-ES	253Vac	12.847	3230	46Vdc	64.921	2979
HYD 6000-ES	207Vac	16.001	3296	48Vdc	63.006	3033
HYD 6000-ES	230Vac	14.348	3285	48Vdc	63.014	3034
HYD 6000-ES	253Vac	13.053	3279	48Vdc	63.031	3035
HYD 6000-ES	207Vac	15.948	3277	58Vdc	52.073	3032
HYD 6000-ES	230Vac	14.280	3261	58Vdc	52.064	3032
HYD 6000-ES	253Vac	12.931	3248	58Vdc	52.044	3030
Type	U (V)	I (A) DC	P (W) DC	U (V)	I (A) AC	P (W) AC
Battery discharging mode						
HYD 6000-ES	46Vdc	69.977	3221	207Vac/50Hz	14.851	2989
HYD 6000-ES	46Vdc	69.945	3219	230Vac/50Hz	13.459	2992
HYD 6000-ES	46Vdc	69.948	3220	253Vac/50Hz	12.279	2990
HYD 6000-ES	48Vdc	66.861	3224	207Vac/50Hz	14.851	2995
HYD 6000-ES	48Vdc	66.998	3222	230Vac/50Hz	13.447	2998
HYD 6000-ES	48Vdc	66.974	3222	253Vac/50Hz	12.305	2996



**BUREAU
VERITAS**

Test Report No: LD190808N030

HYD 6000-ES	58Vdc	56.462	3245	207Vac/50Hz	15.013	3011
HYD 6000-ES	58Vdc	56.415	3245	230Vac/50Hz	13.990	3019
HYD 6000-ES	58Vdc	56.426	3244	253Vac/50Hz	12.403	3024
HYD 6000-ES	46Vdc	69.969	3220	207Vac/60Hz	14.849	2989
HYD 6000-ES	46Vdc	69.951	3222	230Vac/60Hz	14.851	2989
HYD 6000-ES	46Vdc	69.951	3220	253Vac/60Hz	12.281	2991
HYD 6000-ES	48Vdc	66.859	3224	207Vac/60Hz	14.848	2995
HYD 6000-ES	48Vdc	66.995	3222	230Vac/60Hz	13.449	2998
HYD 6000-ES	48Vdc	66.969	3221	253Vac/60Hz	12.302	2996
HYD 6000-ES	58Vdc	56.459	3244	207Vac/60Hz	15.009	3010
HYD 6000-ES	58Vdc	56.409	3245	230Vac/60Hz	14.003	3019
HYD 6000-ES	58Vdc	56.431	3243	253Vac/60Hz	12.411	3023
Type	U (V)	I (A) DC	P (W) DC	U (V)	I (A) AC	P (W) AC
PV input for battery charging and AC output mode						
HYD 6000-ES	90Vdc	7.208	646	230Vac/50Hz	0.010	2
HYD 6000-ES				46Vdc	11.891	548
HYD 6000-ES	300Vdc	20.66	6212	230Vac/50Hz	12.615	2880
HYD 6000-ES				46Vdc	64.941	2989
HYD 6000-ES	360Vdc	17.376	6216	230Vac/50Hz	12.911	2954
HYD 6000-ES				46Vdc	64.970	2990
HYD 6000-ES	520Vdc	12.029	6231	230Vac/50Hz	13.014	2956
HYD 6000-ES				46Vdc	64.986	2988
HYD 6000-ES	580Vdc	0.519	298	230Vac/50Hz	0.015	2
HYD 6000-ES				46Vdc	5.133	236
HYD 6000-ES	90Vdc	7.199	646	230Vac/50Hz	0.010	1
HYD 6000-ES				48Vdc	11.496	549
HYD 6000-ES	300Vdc	20.738	6214	230Vac/50Hz	12.676	2895
HYD 6000-ES				48Vdc	62.402	2995
HYD 6000-ES	360Vdc	17.291	6225	230Vac/50Hz	12.749	2911
HYD 6000-ES				48Vdc	62.464	2997
HYD 6000-ES	520Vdc	12.024	6232	230Vac/50Hz	12.83	2909
HYD 6000-ES				48Vdc	63.358	3037
HYD 6000-ES	580Vdc	0.520	299	230Vac/50Hz	0.010	1
HYD 6000-ES				48Vdc	4.924	236
HYD 6000-ES	90Vdc	7.151	646	230Vac/50Hz	0.010	1
HYD 6000-ES				58Vdc	9.396	548
HYD 6000-ES	300Vdc	20.776	6216	230Vac/50Hz	12.708	2899
HYD 6000-ES				58Vdc	51.45	2999
HYD 6000-ES	360Vdc	17.318	6226	230Vac/50Hz	12.883	2936
HYD 6000-ES				58Vdc	51.388	2995
HYD 6000-ES	520Vdc	12.035	6230	230Vac/50Hz	13.158	2990
HYD 6000-ES				58Vdc	51.379	2992
HYD 6000-ES	580Vdc	0.515	297	230Vac/50Hz	0.010	1
HYD 6000-ES				58Vdc	3.950	230
HYD 6000-ES	90Vdc	7.227	647	230Vac/60Hz	0.011	2
HYD 6000-ES				46Vdc	11.886	548
HYD 6000-ES	300Vdc	20.659	6212	230Vac/60Hz	12.610	2879
HYD 6000-ES				46Vdc	64.935	2989
HYD 6000-ES	360Vdc	17.206	6209	230Vac/60Hz	12.876	2947



HYD 6000-ES				46Vdc	64.953	2989
HYD 6000-ES	520Vdc	12.028	6231	230Vac/60Hz	13.030	2954
HYD 6000-ES				46Vdc	64.333	2987
HYD 6000-ES	580Vdc	0.518	298	230Vac/60Hz	0.015	2
HYD 6000-ES				46Vdc	5.132	237
HYD 6000-ES	90Vdc	7.135	644	230Vac/60Hz	0.012	2
HYD 6000-ES				48Vdc	11.491	554
HYD 6000-ES	300Vdc	20.738	6215	230Vac/60Hz	12.644	2890
HYD 6000-ES				48Vdc	62.383	2994
HYD 6000-ES	360Vdc	17.292	6225	230Vac/60Hz	12.747	2914
HYD 6000-ES				48Vdc	62.467	2997
HYD 6000-ES	520Vdc	12.024	6232	230Vac/60Hz	12.825	2909
HYD 6000-ES				48Vdc	63.353	3037
HYD 6000-ES	580Vdc	0.518	298	230Vac/60Hz	0.010	1
HYD 6000-ES				48Vdc	4.929	237
HYD 6000-ES	90Vdc	7.188	646	230Vac/60Hz	0.010	1
HYD 6000-ES				58Vdc	9.396	549
HYD 6000-ES	300Vdc	20.778	6216	230Vac/60Hz	12.708	2899
HYD 6000-ES				58Vdc	51.444	2999
HYD 6000-ES	360Vdc	17.319	6226	230Vac/60Hz	12.865	2935
HYD 6000-ES				58Vdc	51.367	2993
HYD 6000-ES	520Vdc	12.031	6231	230Vac/60Hz	13.176	2990
HYD 6000-ES				58Vdc	51.362	2991
HYD 6000-ES	580Vdc	0.518	299	230Vac/60Hz	0.015	3
HYD 6000-ES				58Vdc	3.947	230
supplementary information						

4.2.2.6 TABLE: mains supply electrical data in normal condition						P
Type	U (V)	I (A) DC	P (W) DC	U (V)	I (A) AC	P (W) AC
PV Input mode						
HYD 5000-ES	90Vdc	8.761	793	230V/50Hz	3.489	730
HYD 5000-ES	250Vdc	20.791	5192	230V/50Hz	21.532	4957
HYD 5000-ES	360Vdc	14.296	5106	230V/50Hz	21.451	4941
HYD 5000-ES	520Vdc	10.031	5173	230V/50Hz	21.847	4996
HYD 5000-ES	580Vdc	0.485	277	230V/50Hz	1.074	247
HYD 5000-ES	90Vdc	9.225	823	230V/60Hz	3.645	758
HYD 5000-ES	250Vdc	20.803	5210	230V/60Hz	21.595	4965
HYD 5000-ES	360Vdc	14.316	5114	230V/60Hz	21.484	4948
HYD 5000-ES	520Vdc	10.152	5235	230V/60Hz	22.076	5049
HYD 5000-ES	580Vdc	0.493	285	230V/60Hz	1.109	255
Type	U (V)	I (A) DC	P (W) DC	U (V)	I (A) DC	P (W) DC
PV charging mode						
HYD 5000-ES	90Vdc	9.005	793	46Vdc	15.368	705
HYD 5000-ES	250Vdc	12.896	3187	46Vdc	64.253	2945
HYD 5000-ES	360Vdc	8.863	3194	46Vdc	65.352	2994
HYD 5000-ES	520Vdc	6.161	3197	46Vdc	65.158	2982
HYD 5000-ES	580Vdc	0.480	277	46Vdc	4.725	217
HYD 5000-ES	90Vdc	8.763	792	48Vdc	14.422	696
HYD 5000-ES	250Vdc	12.759	3188	48Vdc	61.287	2954



**BUREAU
VERITAS**

Test Report No: LD190808N030

HYD 5000-ES	360Vdc	8.881	3195	48Vdc	62.373	3005
HYD 5000-ES	520Vdc	6.160	3197	48Vdc	62.080	2988
HYD 5000-ES	580Vdc	0.4861	277	48Vdc	4.581	219
HYD 5000-ES	90Vdc	8.871	794	58Vdc	11.664	677
HYD 5000-ES	250Vdc	12.817	3189	58Vdc	51.363	2978
HYD 5000-ES	360Vdc	8.853	3193	58Vdc	51.655	2999
HYD 5000-ES	520Vdc	6.152	3196	58Vdc	52.150	3026
HYD 5000-ES	580Vdc	0.483	277	58Vdc	2.912	169
Type	U (V)	I (A) AC	P (W) AC	U (V)	I (A) DC	P (W) DC
AC charging mode						
HYD 5000-ES	207Vac	15.715	3243	46Vdc	64.926	2978
HYD 5000-ES	230Vac	14.140	3236	46Vdc	64.906	2978
HYD 5000-ES	253Vac	12.845	3229	46Vdc	64.918	2978
HYD 5000-ES	207Vac	15.959	3291	48Vdc	62.940	3030
HYD 5000-ES	230Vac	14.334	3281	48Vdc	62.921	3029
HYD 5000-ES	253Vac	13.034	3276	48Vdc	62.913	3029
HYD 5000-ES	207Vac	15.906	3268	58Vdc	51.924	3024
HYD 5000-ES	230Vac	14.246	3253	58Vdc	51.930	3024
HYD 5000-ES	253Vac	12.897	3242	58Vdc	51.944	3025
Type	U (V)	I (A) DC	P (W) DC	U (V)	I (A) AC	P (W) AC
Battery discharging mode						
HYD 5000-ES	46Vdc	69.978	3222	207Vac/50Hz	14.848	2990
HYD 5000-ES	46Vdc	69.956	3221	230Vac/50Hz	13.479	2993
HYD 5000-ES	46Vdc	69.931	3219	253Vac/50Hz	12.280	2990
HYD 5000-ES	48Vdc	66.866	3223	207Vac/50Hz	14.864	2995
HYD 5000-ES	48Vdc	66.937	3223	230Vac/50Hz	13.451	2997
HYD 5000-ES	48Vdc	67.001	3222	253Vac/50Hz	12.314	2997
HYD 5000-ES	58Vdc	56.431	3245	207Vac/50Hz	15.021	3013
HYD 5000-ES	58Vdc	56.411	3244	230Vac/50Hz	13.627	3018
HYD 5000-ES	58Vdc	56.442	3245	253Vac/50Hz	12.419	3024
HYD 5000-ES	46Vdc	69.985	3223	207Vac/60Hz	14.851	2992
HYD 5000-ES	46Vdc	69.961	3222	230Vac/60Hz	13.475	2993
HYD 5000-ES	46Vdc	69.929	3218	253Vac/60Hz	12.279	2990
HYD 5000-ES	48Vdc	66.871	3223	207Vac/60Hz	14.866	2995
HYD 5000-ES	48Vdc	66.943	3222	230Vac/60Hz	13.453	2997
HYD 5000-ES	48Vdc	67.012	3219	253Vac/60Hz	12.312	2998
HYD 5000-ES	58Vdc	56.429	3245	207Vac/60Hz	15.018	3013
HYD 5000-ES	58Vdc	56.415	3244	230Vac/60Hz	13.631	3018
HYD 5000-ES	58Vdc	56.439	3245	253Vac/60Hz	12.421	3024
Type	U (V)	I (A) DC	P (W) DC	U (V)	I (A) AC	P (W) AC
PV input for battery charging and AC output mode						
HYD 5000-ES	90Vdc	8.875	794	230Vac/50Hz	0.015	3
HYD 5000-ES				46Vdc	15.238	700
HYD 5000-ES	250Vdc	20.966	5216	230Vac/50Hz	8.569	1924
HYD 5000-ES				46Vdc	64.936	2977
HYD 5000-ES	360Vdc	14.584	5234	230Vac/50Hz	8.785	1975
HYD 5000-ES				46Vdc	64.928	2975
HYD 5000-ES	520Vdc	10.074	5237	230Vac/50Hz	9.034	2005
HYD 5000-ES				46Vdc	64.935	2972



**BUREAU
VERITAS**

Test Report No: LD190808N030

HYD 5000-ES	580Vdc	0.488	278	230Vac/50Hz	0.012	2
HYD 5000-ES				46Vdc	4.761	218
HYD 5000-ES	90Vdc	8.713	791	230Vac/50Hz	0.013	2
HYD 5000-ES				48Vdc	14.642	704
HYD 5000-ES	250Vdc	20.755	5210	230Vac/50Hz	7.982	1785
HYD 5000-ES				48Vdc	64.929	3116
HYD 5000-ES	360Vdc	14.273	5140	230Vac/50Hz	7.948	1782
HYD 5000-ES				48Vdc	65.01	3118
HYD 5000-ES	520Vdc	10.041	5191	230Vac/50Hz	8.243	1821
HYD 5000-ES				48Vdc	64.968	3114
HYD 5000-ES	580Vdc	0.484	278	230Vac/50Hz	0.012	2
HYD 5000-ES				48Vdc	4.473	215
HYD 5000-ES	90Vdc	8.870	794	230Vac/50Hz	0.010	1
HYD 5000-ES				58Vdc	11.606	676
HYD 5000-ES	250Vdc	20.933	5215	230Vac/50Hz	8.434	1891
HYD 5000-ES				58Vdc	52.101	3032
HYD 5000-ES	360Vdc	14.631	5233	230Vac/50Hz	8.702	1951
HYD 5000-ES				58Vdc	52.02	3026
HYD 5000-ES	520Vdc	10.001	5188	230Vac/50Hz	8.517	1886
HYD 5000-ES				58Vdc	52.974	3079
HYD 5000-ES	580Vdc	0.481	277	230Vac/50Hz	0.009	1
HYD 5000-ES				58Vdc	3.669	213
HYD 5000-ES	90Vdc	8.863	792	230Vac/60Hz	0.015	3
HYD 5000-ES				46Vdc	15.234	698
HYD 5000-ES	250Vdc	20.959	5213	230Vac/60Hz	8.571	1926
HYD 5000-ES				46Vdc	64.932	2975
HYD 5000-ES	360Vdc	14.579	5229	230Vac/60Hz	8.787	1977
HYD 5000-ES				46Vdc	64.923	2973
HYD 5000-ES	520Vdc	10.063	5235	230Vac/60Hz	9.036	2007
HYD 5000-ES				46Vdc	64.932	2970
HYD 5000-ES	580Vdc	0.485	276	230Vac/60Hz	0.012	2
HYD 5000-ES				46Vdc	4.761	218
HYD 5000-ES	90Vdc	8.864	794	230Vac/60Hz	0.013	2
HYD 5000-ES				48Vdc	14.64	704
HYD 5000-ES	250Vdc	20.754	5210	230Vac/60Hz	7.976	1786
HYD 5000-ES				48Vdc	64.904	3115
HYD 5000-ES	360Vdc	14.275	5140	230Vac/60Hz	7.944	1782
HYD 5000-ES				48Vdc	64.994	3118
HYD 5000-ES	520Vdc	10.038	5190	230Vac/60Hz	8.239	1820
HYD 5000-ES				48Vdc	64.966	3114
HYD 5000-ES	580Vdc	0.484	278	230Vac/60Hz	0.011	2
HYD 5000-ES				48Vdc	4.474	215
HYD 5000-ES	90Vdc	8.922	794	230Vac/60Hz	0.010	1
HYD 5000-ES				58Vdc	11.605	676
HYD 5000-ES	250Vdc	20.933	5215	230Vac/60Hz	8.351	1872
HYD 5000-ES				58Vdc	52.407	3050
HYD 5000-ES	360Vdc	14.631	5233	230Vac/60Hz	8.696	1950
HYD 5000-ES				58Vdc	51.997	3024
HYD 5000-ES	520Vdc	10.000	5189	230Vac/60Hz	8.533	1889



**BUREAU
VERITAS**

Test Report No: LD190808N030

HYD 5000-ES				58Vdc	52.990	3080
HYD 5000-ES	580Vdc	0.480	277	230Vac/60Hz	0.009	1
HYD 5000-ES				58Vdc	3.675	214
supplementary information						

4.2.2.6 TABLE: mains supply electrical data in normal condition							P
Type	U (V)	I (A) DC	P (W) DC	U (V)	I (A) AC	P (W) AC	
PV Input mode							
HYD 4600-ES	90Vdc	9.4446	851	230V/50Hz	3.4426	784	
HYD 4600-ES	230Vdc	21.0247	4779	230V/50Hz	19.6530	4539	
HYD 4600-ES	360Vdc	13.4159	4781	230V/50Hz	20.0803	4637	
HYD 4600-ES	520Vdc	9.3467	4786	230V/50Hz	19.9636	4608	
HYD 4600-ES	580Vdc	0.5193	295	230V/50Hz	1.2856	267	
HYD 4600-ES	90Vdc	9.4376	848	230V/60Hz	3.4382	780	
HYD 4600-ES	230Vdc	21.0117	4776	230V/60Hz	19.6486	4535	
HYD 4600-ES	360Vdc	13.4088	4778	230V/60Hz	20.0752	4633	
HYD 4600-ES	520Vdc	9.3329	4785	230V/60Hz	19.9351	4605	
HYD 4600-ES	580Vdc	0.5085	297	230V/60Hz	1.2912	265	
Type	U (V)	I (A) DC	P (W) DC	U (V)	I (A) DC	P (W) DC	
PV charging mode							
HYD 4600-ES	90Vdc	9.4312	845	46Vdc	16.87	776	
HYD 4600-ES	230Vdc	14.004	3221	46Vdc	64.186	2967	
HYD 4600-ES	360Vdc	9.119	3199	46Vdc	64.779	2986	
HYD 4600-ES	520Vdc	9.157	3204	46Vdc	64.885	2991	
HYD 4600-ES	580Vdc	0.521	297	46Vdc	5.891	271	
HYD 4600-ES	90Vdc	9.425	840	48Vdc	16.021	769	
HYD 4600-ES	230Vdc	14.025	3220	48Vdc	62.781	2986	
HYD 4600-ES	360Vdc	8.985	3238	48Vdc	63.597	3048	
HYD 4600-ES	520Vdc	6.187	3219	48Vdc	63.166	3035	
HYD 4600-ES	580Vdc	0.5072	290	48Vdc	5.438	261	
HYD 4600-ES	90Vdc	9.4229	839	58Vdc	13.276	770	
HYD 4600-ES	230Vdc	14.022	3225	58Vdc	51.585	2999	
HYD 4600-ES	360Vdc	9.028	3239	58Vdc	52.471	3046	
HYD 4600-ES	520Vdc	6.247	3243	58Vdc	52.882	3065	
HYD 4600-ES	580Vdc	0.506	292	58Vdc	4.552	264	
Type	U (V)	I (A) AC	P (W) AC	U (V)	I (A) DC	P (W) DC	
AC charging mode							
HYD 4600-ES	207Vac	15.762	3241	46Vdc	64.952	2992	
HYD 4600-ES	230Vac	14.257	3254	46Vdc	64.913	2987	
HYD 4600-ES	253Vac	12.92	3235	46Vdc	64.918	2988	
HYD 4600-ES	207Vac	15.801	3246	48Vdc	62.338	2996	
HYD 4600-ES	230Vac	14.256	3253	48Vdc	62.444	3001	
HYD 4600-ES	253Vac	12.934	3238	48Vdc	62.351	2996	
HYD 4600-ES	207Vac	15.766	3243	58Vdc	52.013	3020	
HYD 4600-ES	230Vac	14.067	3212	58Vdc	51.916	3015	
HYD 4600-ES	253Vac	12.961	3243	58Vdc	52.017	3021	
Type	U (V)	I (A) DC	P (W) DC	U (V)	I (A) AC	P (W) AC	
Battery discharging mode							
HYD 4600-ES	46Vdc	69.912	3217	207Vac/50Hz	14.812	2993	



**BUREAU
VERITAS**

Test Report No: LD190808N030

HYD 4600-ES	46Vdc	69.902	3215	230Vac/50Hz	13.427	2993
HYD 4600-ES	46Vdc	69.853	3214	253Vac/50Hz	12.25	2991
HYD 4600-ES	48Vdc	66.792	3218	207Vac/50Hz	14.811	2998
HYD 4600-ES	48Vdc	66.907	3217	230Vac/50Hz	13.416	3000
HYD 4600-ES	48Vdc	66.922	3215	253Vac/50Hz	12.286	2999
HYD 4600-ES	58Vdc	56.349	3239	207Vac/50Hz	14.989	3014
HYD 4600-ES	58Vdc	56.373	3238	230Vac/50Hz	13.595	3021
HYD 4600-ES	58Vdc	56.32	3238	253Vac/50Hz	12.399	3026
HYD 4600-ES	46Vdc	69.9	3216	207Vac/60Hz	14.815	2993
HYD 4600-ES	46Vdc	69.882	3215	230Vac/60Hz	13.421	2993
HYD 4600-ES	46Vdc	69.855	3214	253Vac/60Hz	12.253	2991
HYD 4600-ES	48Vdc	66.791	3219	207Vac/60Hz	14.813	2999
HYD 4600-ES	48Vdc	66.904	3217	230Vac/60Hz	13.419	3000
HYD 4600-ES	48Vdc	66.933	3215	253Vac/60Hz	12.287	2999
HYD 4600-ES	58Vdc	56.353	3240	207Vac/60Hz	14.995	3013
HYD 4600-ES	58Vdc	56.371	3239	230Vac/60Hz	13.593	3020
HYD 4600-ES	58Vdc	56.323	3238	253Vac/60Hz	12.401	3026
Type	U (V)	I (A) DC	P (W) DC	U (V)	I (A) AC	P (W) AC
PV input for battery charging and AC output mode						
HYD 4600-ES	90Vdc	9.420	848	230Vac/50Hz	0.013	2
HYD 4600-ES				46Vdc	17.283	795
HYD 4600-ES	230Vdc	21.000	4776	230Vac/50Hz	6.261	1440
HYD 4600-ES				46Vdc	64.865	2998
HYD 4600-ES	360Vdc	13.391	4798	230Vac/50Hz	6.422	1477
HYD 4600-ES				46Vdc	64.866	2995
HYD 4600-ES	520Vdc	9.322	4783	230Vac/50Hz	6.35	1460
HYD 4600-ES				46Vdc	64.973	2998
HYD 4600-ES	580Vdc	0.494	292	230Vac/50Hz	0.011	3
HYD 4600-ES				46Vdc	5.109	235
HYD 4600-ES	90Vdc	9.413	845	230Vac/50Hz	0.013	2
HYD 4600-ES				48Vdc	15.417	740
HYD 4600-ES	230Vdc	20.987	4773	230Vac/50Hz	6.161	1417
HYD 4600-ES				48Vdc	63.005	3032
HYD 4600-ES	360Vdc	13.384	4775	230Vac/50Hz	6.148	1413
HYD 4600-ES				48Vdc	63.103	3037
HYD 4600-ES	520Vdc	9.308	4782	230Vac/50Hz	6.228	1432
HYD 4600-ES				48Vdc	62.904	3025
HYD 4600-ES	580Vdc	0.484	296	230Vac/50Hz	0.013	2
HYD 4600-ES				48Vdc	5.104	245
HYD 4600-ES	90Vdc	9.419	846	230Vac/50Hz	0.013	2
HYD 4600-ES				58Vdc	13.692	794
HYD 4600-ES	230Vdc	20.987	4775	230Vac/50Hz	6.255	1443
HYD 4600-ES				58Vdc	51.621	2996
HYD 4600-ES	360Vdc	13.377	4797	230Vac/50Hz	6.425	1479
HYD 4600-ES				58Vdc	51.712	2999
HYD 4600-ES	520Vdc	9.311	4781	230Vac/50Hz	6.343	1465
HYD 4600-ES				58Vdc	51.585	2995
HYD 4600-ES	580Vdc	0.491	293	230Vac/50Hz	0.011	2
HYD 4600-ES				58Vdc	4.069	237



**BUREAU
VERITAS**

Test Report No: LD190808N030

HYD 4600-ES	90Vdc	9.435	850	230Vac/60Hz	0.012	2
HYD 4600-ES				46Vdc	17.245	792
HYD 4600-ES	230Vdc	21.015	4778	230Vac/60Hz	6.223	1437
HYD 4600-ES				46Vdc	64.827	2995
HYD 4600-ES	360Vdc	13.406	4800	230Vac/60Hz	6.384	1474
HYD 4600-ES				46Vdc	64.828	2992
HYD 4600-ES	520Vdc	9.337	4785	230Vac/60Hz	6.312	1457
HYD 4600-ES				46Vdc	64.935	2995
HYD 4600-ES	580Vdc	0.509	294	230Vac/60Hz	0.013	3
HYD 4600-ES				46Vdc	5.071	232
HYD 4600-ES	90Vdc	9.428	847	230Vac/60Hz	0.012	2
HYD 4600-ES				48Vdc	15.379	737
HYD 4600-ES	230Vdc	21.002	4775	230Vac/60Hz	6.123	1414
HYD 4600-ES				48Vdc	62.967	3029
HYD 4600-ES	360Vdc	13.399	4777	230Vac/60Hz	6.11	1410
HYD 4600-ES				48Vdc	63.065	3034
HYD 4600-ES	520Vdc	9.323	4784	230Vac/60Hz	6.19	1429
HYD 4600-ES				48Vdc	62.866	3022
HYD 4600-ES	580Vdc	0.499	298	230Vac/60Hz	0.012	2
HYD 4600-ES				48Vdc	5.066	242
HYD 4600-ES	90Vdc	9.404	843	230Vac/60Hz	0.011	2
HYD 4600-ES				58Vdc	13.654	791
HYD 4600-ES	230Vdc	20.972	4772	230Vac/60Hz	6.217	1440
HYD 4600-ES				58Vdc	51.583	2993
HYD 4600-ES	360Vdc	13.362	4794	230Vac/60Hz	6.387	1476
HYD 4600-ES				58Vdc	51.674	2996
HYD 4600-ES	520Vdc	9.296	4778	230Vac/60Hz	6.305	1462
HYD 4600-ES				58Vdc	51.547	2992
HYD 4600-ES	580Vdc	0.476	290	230Vac/60Hz	0.013	2
HYD 4600-ES				58Vdc	4.031	234

supplementary information

4.2.2.6 TABLE: mains supply electrical data in normal condition						P
Type	U (V)	I (A) DC	P (W) DC	U (V)	I (A) AC	P (W) AC
PV Input mode						
HYD 4000-ES	90Vdc	11.008	989	230V/50Hz	4.228	914
HYD 4000-ES	200Vdc	20.863	4199	230V/50Hz	17.377	3989
HYD 4000-ES	360Vdc	11.684	4139	230V/50Hz	17.450	4008
HYD 4000-ES	520Vdc	8.156	4194	230V/50Hz	17.754	4047
HYD 4000-ES	580Vdc	0.405	227	230V/50Hz	1.436	199
HYD 4000-ES	90Vdc	11.120	990	230V/60Hz	4.256	912
HYD 4000-ES	200Vdc	20.864	4187	230V/60Hz	17.322	3974
HYD 4000-ES	360Vdc	11.632	4134	230V/60Hz	17.440	4002
HYD 4000-ES	520Vdc	8.231	4215	230V/60Hz	17.884	4071
HYD 4000-ES	580Vdc	0.404	227	230V/60Hz	1.435	198
Type	U (V)	I (A) DC	P (W) DC	U (V)	I (A) DC	P (W) DC
PV charging mode						
HYD 4000-ES	90Vdc	10.860	970	46Vdc	18.639	862



**BUREAU
VERITAS**

Test Report No: LD190808N030

HYD 4000-ES	200Vdc	16.186	3229	46Vdc	64.192	2964
HYD 4000-ES	360Vdc	9.120	3201	46Vdc	64.792	2988
HYD 4000-ES	520Vdc	9.160	3206	46Vdc	64.897	2992
HYD 4000-ES	580Vdc	0.408	228	46Vdc	3.568	165
HYD 4000-ES	90Vdc	10.859	971	48Vdc	17.943	862
HYD 4000-ES	200Vdc	15.998	3222	48Vdc	62.792	2988
HYD 4000-ES	360Vdc	8.991	3243	48Vdc	63.601	3051
HYD 4000-ES	520Vdc	6.193	3223	48Vdc	63.177	3041
HYD 4000-ES	580Vdc	0.398	228	48Vdc	3.554	171
HYD 4000-ES	90Vdc	10.645	959	58Vdc	14.468	841
HYD 4000-ES	200Vdc	16.188	3229	58Vdc	51.583	2997
HYD 4000-ES	360Vdc	9.030	3244	58Vdc	52.483	3048
HYD 4000-ES	520Vdc	6.251	3245	58Vdc	52.885	3069
HYD 4000-ES	580Vdc	0.396	226	58Vdc	2.875	167
Type	U (V)	I (A) AC	P (W) AC	U (V)	I (A) DC	P (W) DC
AC charging mode						
HYD 4000-ES	207Vac	15.795	3246	46Vdc	64.985	2994
HYD 4000-ES	230Vac	14.290	3259	46Vdc	64.946	2989
HYD 4000-ES	253Vac	12.953	3240	46Vdc	64.951	2990
HYD 4000-ES	207Vac	15.834	3251	48Vdc	62.371	2998
HYD 4000-ES	230Vac	14.289	3258	48Vdc	62.477	3003
HYD 4000-ES	253Vac	12.967	3243	48Vdc	62.384	2998
HYD 4000-ES	207Vac	15.799	3248	58Vdc	52.046	3022
HYD 4000-ES	230Vac	14.100	3217	58Vdc	51.949	3017
HYD 4000-ES	253Vac	12.994	3248	58Vdc	52.050	3023
Type	U (V)	I (A) DC	P (W) DC	U (V)	I (A) AC	P (W) AC
Battery discharging mode						
HYD 4000-ES	46Vdc	69.980	3223	207Vac/50Hz	14.840	2991
HYD 4000-ES	46Vdc	69.970	3221	230Vac/50Hz	13.455	2991
HYD 4000-ES	46Vdc	69.921	3220	253Vac/50Hz	12.278	2989
HYD 4000-ES	48Vdc	66.860	3224	207Vac/50Hz	14.839	2996
HYD 4000-ES	48Vdc	66.975	3223	230Vac/50Hz	13.444	2998
HYD 4000-ES	48Vdc	66.990	3221	253Vac/50Hz	12.314	2997
HYD 4000-ES	58Vdc	56.417	3245	207Vac/50Hz	15.017	3012
HYD 4000-ES	58Vdc	56.441	3244	230Vac/50Hz	13.623	3019
HYD 4000-ES	58Vdc	56.388	3244	253Vac/50Hz	12.427	3024
HYD 4000-ES	46Vdc	69.968	3222	207Vac/60Hz	14.843	2991
HYD 4000-ES	46Vdc	69.950	3221	230Vac/60Hz	13.449	2991
HYD 4000-ES	46Vdc	69.923	3220	253Vac/60Hz	12.281	2989
HYD 4000-ES	48Vdc	66.859	3225	207Vac/60Hz	14.841	2997
HYD 4000-ES	48Vdc	66.972	3223	230Vac/60Hz	13.447	2998
HYD 4000-ES	48Vdc	67.001	3221	253Vac/60Hz	12.315	2997
HYD 4000-ES	58Vdc	56.421	3246	207Vac/60Hz	15.023	3011
HYD 4000-ES	58Vdc	56.439	3245	230Vac/60Hz	13.621	3018
HYD 4000-ES	58Vdc	56.391	3244	253Vac/60Hz	12.429	3024
Type	U (V)	I (A) DC	P (W) DC	U (V)	I (A) AC	P (W) AC
PV input for battery charging and AC output mode						
HYD 4000-ES	90Vdc	10.742	961	230Vac/50Hz	0.013	2
HYD 4000-ES				46Vdc	18.530	857



**BUREAU
VERITAS**

Test Report No: LD190808N030

HYD 4000-ES	200Vdc	21.110	4213	230Vac/50Hz	4.256	920
HYD 4000-ES				46Vdc	64.867	2995
HYD 4000-ES	360Vdc	11.698	4200	230Vac/50Hz	4.400	955
HYD 4000-ES				46Vdc	64.868	2993
HYD 4000-ES	520Vdc	8.115	4203	230Vac/50Hz	4.578	971
HYD 4000-ES				46Vdc	64.979	2996
HYD 4000-ES	580Vdc	0.399	227	230Vac/50Hz	0.013	2
HYD 4000-ES				46Vdc	3.754	173
HYD 4000-ES	90Vdc	10.733	961	230Vac/50Hz	0.013	2
HYD 4000-ES				48Vdc	17.809	859
HYD 4000-ES	200Vdc	21.242	4215	230Vac/50Hz	4.118	887
HYD 4000-ES				48Vdc	63.003	3037
HYD 4000-ES	360Vdc	11.618	4187	230Vac/50Hz	4.328	939
HYD 4000-ES				48Vdc	63.104	3039
HYD 4000-ES	520Vdc	8.187	4242	230Vac/50Hz	4.644	994
HYD 4000-ES				48Vdc	62.906	3027
HYD 4000-ES	580Vdc	0.407	227	230Vac/50Hz	0.012	2
HYD 4000-ES				48Vdc	3.559	171
HYD 4000-ES	90Vdc	10.592	958	230Vac/50Hz	0.010	1
HYD 4000-ES				58Vdc	14.576	848
HYD 4000-ES	200Vdc	20.897	4205	230Vac/50Hz	4.294	922
HYD 4000-ES				58Vdc	51.887	3015
HYD 4000-ES	360Vdc	11.777	4239	230Vac/50Hz	4.597	996
HYD 4000-ES				58Vdc	51.974	3018
HYD 4000-ES	520Vdc	8.178	4243	230Vac/50Hz	4.765	1022
HYD 4000-ES				58Vdc	52.183	3029
HYD 4000-ES	580Vdc	0.397	226	230Vac/50Hz	0.010	1
HYD 4000-ES				58Vdc	2.966	172
HYD 4000-ES	90Vdc	10.601	958	230Vac/60Hz	0.010	1
HYD 4000-ES				46Vdc	18.54	857
HYD 4000-ES	200Vdc	21.112	4212	230Vac/60Hz	4.252	921
HYD 4000-ES				46Vdc	64.865	2993
HYD 4000-ES	360Vdc	11.698	4200	230Vac/60Hz	4.412	956
HYD 4000-ES				46Vdc	64.870	2994
HYD 4000-ES	520Vdc	8.114	4204	230Vac/60Hz	4.574	976
HYD 4000-ES				46Vdc	64.981	2995
HYD 4000-ES	580Vdc	0.397	226	230Vac/60Hz	0.012	2
HYD 4000-ES				46Vdc	3.752	173
HYD 4000-ES	90Vdc	10.774	961	230Vac/60Hz	0.012	1
HYD 4000-ES				48Vdc	17.806	859
HYD 4000-ES	200Vdc	21.158	4212	230Vac/60Hz	4.099	883
HYD 4000-ES				48Vdc	62.967	3035
HYD 4000-ES	360Vdc	11.621	4188	230Vac/60Hz	4.332	941
HYD 4000-ES				48Vdc	63.11	3040
HYD 4000-ES	520Vdc	8.191	4243	230Vac/60Hz	4.646	995
HYD 4000-ES				48Vdc	62.911	3027
HYD 4000-ES	580Vdc	0.395	226	230Vac/60Hz	0.013	2
HYD 4000-ES				48Vdc	3.559	171
HYD 4000-ES	90Vdc	10.581	952	230Vac/60Hz	0.010	1



HYD 4000-ES				58Vdc	14.569	847
HYD 4000-ES	200Vdc	20.895	4203	230Vac/60Hz	4.289	920
HYD 4000-ES				58Vdc	51.877	3014
HYD 4000-ES	360Vdc	11.769	4237	230Vac/60Hz	4.594	995
HYD 4000-ES				58Vdc	51.968	3016
HYD 4000-ES	520Vdc	8.168	4241	230Vac/60Hz	4.759	1021
HYD 4000-ES				58Vdc	52.178	3027
HYD 4000-ES	580Vdc	0.398	226	230Vac/60Hz	0.010	1
HYD 4000-ES				58Vdc	2.965	172

supplementary information

4.2.2.6 TABLE: mains supply electrical data in normal condition						P
Type	U (V)	I (A) DC	P (W) DC	U (V)	I (A) AC	P (W) AC
PV Input mode						
HYD 3600-ES	90Vdc	11.76	1049	230V/50Hz	4.458	968
HYD 3600-ES	180Vdc	20.956	3762	230V/50Hz	15.566	3566
HYD 3600-ES	360Vdc	10.531	3808	230V/50Hz	15.976	3659
HYD 3600-ES	520Vdc	7.545	3864	230V/50Hz	16.390	3735
HYD 3600-ES	580Vdc	0.351	197	230V/50Hz	2.373	138
HYD 3600-ES	90Vdc	11.761	1053	230V/60Hz	4.463	973
HYD 3600-ES	180Vdc	21.005	3801	230V/60Hz	15.741	3602
HYD 3600-ES	360Vdc	10.637	3820	230V/60Hz	16.013	3670
HYD 3600-ES	520Vdc	7.549	3869	230V/60Hz	16.458	3746
HYD 3600-ES	580Vdc	0.348	196	230V/60Hz	2.369	138
Type	U (V)	I (A) DC	P (W) DC	U (V)	I (A) DC	P (W) DC
PV charging mode						
HYD 3600-ES	90Vdc	11.627	1048	46Vdc	20.276	935
HYD 3600-ES	180Vdc	18.155	3262	46Vdc	64.946	2993
HYD 3600-ES	360Vdc	8.864	3194	46Vdc	64.947	2990
HYD 3600-ES	520Vdc	6.137	3195	46Vdc	64.96	2988
HYD 3600-ES	580Vdc	0.348	197	46Vdc	3.127	144
HYD 3600-ES	90Vdc	11.725	1049	48Vdc	19.618	943
HYD 3600-ES	180Vdc	18.052	3267	48Vdc	62.367	3006
HYD 3600-ES	360Vdc	8.999	3252	48Vdc	63.447	3056
HYD 3600-ES	520Vdc	6.269	3257	48Vdc	63.369	3050
HYD 3600-ES	580Vdc	0.347	198	48Vdc	2.937	141
HYD 3600-ES	90Vdc	11.657	1048	58Vdc	15.966	929
HYD 3600-ES	180Vdc	18.057	3264	58Vdc	52.053	3025
HYD 3600-ES	360Vdc	9.024	3244	58Vdc	52.447	3046
HYD 3600-ES	520Vdc	6.242	3246	58Vdc	52.968	3073
HYD 3600-ES	580Vdc	0.343	196	58Vdc	2.369	138
Type	U (V)	I (A) AC	P (W) AC	U (V)	I (A) DC	P (W) DC
AC charging mode						
HYD 3600-ES	207Vac	15.887	3266	46Vdc	64.93	2996
HYD 3600-ES	230Vac	14.359	3275	46Vdc	64.822	2991
HYD 3600-ES	253Vac	13.033	3261	46Vdc	64.925	2995
HYD 3600-ES	207Vac	15.865	3262	48Vdc	62.459	3002
HYD 3600-ES	230Vac	14.341	3272	48Vdc	62.559	3006
HYD 3600-ES	253Vac	13.015	3258	48Vdc	62.655	3011



**BUREAU
VERITAS**

Test Report No: LD190808N030

Type	U (V)	I (A) DC	P (W) DC	U (V)	I (A) AC	P (W) AC
HYD 3600-ES	207Vac	15.919	3272	58Vdc	51.858	3011
HYD 3600-ES	230Vac	14.319	3263	58Vdc	51.85	3010
HYD 3600-ES	253Vac	13.081	3273	58Vdc	51.745	3005
HYD 3600-ES	46Vdc	69.957	3221	207Vac/50Hz	14.844	2991
HYD 3600-ES	46Vdc	69.938	3219	230Vac/50Hz	13.467	2990
HYD 3600-ES	46Vdc	69.926	3219	253Vac/50Hz	12.286	2989
HYD 3600-ES	48Vdc	66.833	3223	207Vac/50Hz	14.837	2994
HYD 3600-ES	48Vdc	66.922	3222	230Vac/50Hz	13.437	2997
HYD 3600-ES	48Vdc	66.965	3222	253Vac/50Hz	12.301	2996
HYD 3600-ES	58Vdc	56.427	3246	207Vac/50Hz	15.021	3012
HYD 3600-ES	58Vdc	56.428	3245	230Vac/50Hz	13.634	3019
HYD 3600-ES	58Vdc	56.422	3244	253Vac/50Hz	12.420	3024
HYD 3600-ES	46Vdc	69.961	3223	207Vac/60Hz	14.841	2992
HYD 3600-ES	46Vdc	69.943	3220	230Vac/60Hz	13.447	2990
HYD 3600-ES	46Vdc	69.929	3219	253Vac/60Hz	12.288	2989
HYD 3600-ES	48Vdc	66.829	3224	207Vac/60Hz	14.839	2994
HYD 3600-ES	48Vdc	66.928	3223	230Vac/60Hz	13.439	2997
HYD 3600-ES	48Vdc	66.967	3222	253Vac/60Hz	12.306	2996
HYD 3600-ES	58Vdc	56.435	3245	207Vac/60Hz	15.026	3013
HYD 3600-ES	58Vdc	56.431	3243	230Vac/60Hz	13.629	3017
HYD 3600-ES	58Vdc	56.417	3244	253Vac/60Hz	12.426	3024
HYD 3600-ES	90Vdc	11.773	1049	230Vac/50Hz	0	0
HYD 3600-ES	90Vdc	11.773	1049	46Vdc	20.281	936
HYD 3600-ES	180Vdc	21.164	3808	230Vac/50Hz	2.679	529
HYD 3600-ES	180Vdc	21.164	3808	46Vdc	64.958	2993
HYD 3600-ES	360Vdc	10.558	3819	230Vac/50Hz	2.902	588
HYD 3600-ES	360Vdc	10.558	3819	46Vdc	64.955	2990
HYD 3600-ES	520Vdc	7.392	3844	230Vac/50Hz	3.152	632
HYD 3600-ES	520Vdc	7.392	3844	46Vdc	64.968	2989
HYD 3600-ES	580Vdc	0.346	196	230Vac/50Hz	0	0
HYD 3600-ES	580Vdc	0.346	196	46Vdc	3.128	144
HYD 3600-ES	90Vdc	11.65	1048	230Vac/50Hz	0.015	3
HYD 3600-ES	90Vdc	11.65	1048	48Vdc	19.615	942
HYD 3600-ES	180Vdc	21.014	3804	230Vac/50Hz	2.380	453
HYD 3600-ES	180Vdc	21.014	3804	48Vdc	63.859	3065
HYD 3600-ES	360Vdc	10.723	3842	230Vac/50Hz	2.861	579
HYD 3600-ES	360Vdc	10.723	3842	48Vdc	63.478	3057
HYD 3600-ES	520Vdc	7.402	3845	230Vac/50Hz	2.934	577
HYD 3600-ES	520Vdc	7.402	3845	48Vdc	63.353	3049
HYD 3600-ES	580Vdc	0.347	199	230Vac/50Hz	0	0
HYD 3600-ES	580Vdc	0.347	199	48Vdc	2.939	142
HYD 3600-ES	90Vdc	11.787	1049	230Vac/50Hz	0	0
HYD 3600-ES	90Vdc	11.787	1049	58Vdc	15.959	928
HYD 3600-ES	180Vdc	21.172	3810	230Vac/50Hz	2.765	549
HYD 3600-ES	180Vdc	21.172	3810	58Vdc	51.593	2998



HYD 3600-ES	360Vdc	10.685	3841	230Vac/50Hz	2.924	588
HYD 3600-ES				58Vdc	52.373	3041
HYD 3600-ES	520Vdc	7.420	3846	230Vac/50Hz	3.082	617
HYD 3600-ES				58Vdc	52.477	3046
HYD 3600-ES	580Vdc	0.342	196	230Vac/50Hz	0	0
HYD 3600-ES				58Vdc	2.369	138
HYD 3600-ES	90Vdc	11.695	1049	230Vac/60Hz	0.150	3
HYD 3600-ES				46Vdc	20.281	936
HYD 3600-ES	180Vdc	20.984	3803	230Vac/60Hz	2.644	522
HYD 3600-ES				46Vdc	64.950	2993
HYD 3600-ES	360Vdc	10.638	3821	230Vac/60Hz	3.020	620
HYD 3600-ES				46Vdc	64.944	2990
HYD 3600-ES	520Vdc	7.393	3844	230Vac/60Hz	3.150	632
HYD 3600-ES				46Vdc	64.953	2988
HYD 3600-ES	580Vdc	0.342	196	230Vac/60Hz	0	0
HYD 3600-ES				46Vdc	3.128	144
HYD 3600-ES	90Vdc	11.645	1048	230Vac/60Hz	0.160	4
HYD 3600-ES				48Vdc	19.614	943
HYD 3600-ES	180Vdc	21.014	3804	230Vac/60Hz	2.391	454
HYD 3600-ES				48Vdc	63.869	3066
HYD 3600-ES	360Vdc	10.626	3839	230Vac/60Hz	2.847	576
HYD 3600-ES				48Vdc	63.461	3056
HYD 3600-ES	520Vdc	7.403	3845	230Vac/60Hz	2.927	576
HYD 3600-ES				48Vdc	63.348	3048
HYD 3600-ES	580Vdc	0.345	198	230Vac/60Hz	0	0
HYD 3600-ES				48Vdc	2.939	142
HYD 3600-ES	90Vdc	11.658	1048	230Vac/60Hz	0.012	2
HYD 3600-ES				58Vdc	15.954	928
HYD 3600-ES	180Vdc	21.17	3810	230Vac/60Hz	2.697	531
HYD 3600-ES				58Vdc	51.865	3014
HYD 3600-ES	360Vdc	10.685	3841	230Vac/60Hz	2.926	588
HYD 3600-ES				58Vdc	52.360	3041
HYD 3600-ES	520Vdc	7.422	3845	230Vac/60Hz	3.079	616
HYD 3600-ES				58Vdc	52.481	3047
HYD 3600-ES	580Vdc	0.352	196	230Vac/60Hz	0	0
HYD 3600-ES				58Vdc	2.369	138
supplementary information						

4.2.2.6 TABLE: mains supply electrical data in normal condition							P
Type	U (V)	I (A) DC	P (W) DC	U (V)	I (A) AC	P (W) AC	
PV Input mode							
HYD 3000-ES	90Vdc	13.136	1185	230V/50Hz	4.984	1094	
HYD 3000-ES	160Vdc	19.706	3164	230V/50Hz	13.099	2990	
HYD 3000-ES	360Vdc	8.701	3134	230V/50Hz	13.182	3011	
HYD 3000-ES	520Vdc	6.074	3102	230V/50Hz	13.217	2999	
HYD 3000-ES	580Vdc	0.317	177	230V/50Hz	1.274	149	
HYD 3000-ES	90Vdc	13.215	1184	230V/60Hz	5.0121	1093	
HYD 3000-ES	160Vdc	19.349	3110	230V/60Hz	12.893	2940	
HYD 3000-ES	360Vdc	8.742	3108	230V/60Hz	13.182	3012	



**BUREAU
VERITAS**

Test Report No: LD190808N030

HYD 3000-ES	520Vdc	6.100	3114	230V/60Hz	13.283	3010
HYD 3000-ES	580Vdc	0.327	177	230V/60Hz	1.276	149
Type	U (V)	I (A) DC	P (W) DC	U (V)	I (A) DC	P (W) DC
PV charging mode						
HYD 3000-ES	90Vdc	13.286	1186	46Vdc	23.001	1059
HYD 3000-ES	160Vdc	19.638	3159	46Vdc	62.903	2892
HYD 3000-ES	360Vdc	8.652	3124	46Vdc	63.301	2908
HYD 3000-ES	520Vdc	6.089	3156	46Vdc	64.303	2951
HYD 3000-ES	580Vdc	0.308	177	46Vdc	2.562	118
HYD 3000-ES	90Vdc	13.131	1184	48Vdc	22.018	1060
HYD 3000-ES	160Vdc	19.813	3166	48Vdc	60.312	2901
HYD 3000-ES	360Vdc	8.670	3125	48Vdc	60.603	2913
HYD 3000-ES	520Vdc	6.033	3127	48Vdc	61.010	2930
HYD 3000-ES	580Vdc	0.313	176	48Vdc	2.549	123
HYD 3000-ES	90Vdc	13.068	1182	58Vdc	18.144	1056
HYD 3000-ES	160Vdc	19.769	3165	58Vdc	50.304	2923
HYD 3000-ES	360Vdc	8.844	3194	58Vdc	51.682	3002
HYD 3000-ES	520Vdc	6.089	3157	58Vdc	51.488	2988
HYD 3000-ES	580Vdc	0.316	178	58Vdc	2.059	120
Type	U (V)	I (A) AC	P (W) AC	U (V)	I (A) DC	P (W) DC
AC charging mode						
HYD 3000-ES	207Vac	15.887	3265	46Vdc	64.89	2995
HYD 3000-ES	230Vac	14.359	3276	46Vdc	64.818	2991
HYD 3000-ES	253Vac	13.033	3262	46Vdc	64.919	2993
HYD 3000-ES	207Vac	15.858	3263	48Vdc	62.454	3000
HYD 3000-ES	230Vac	14.339	3273	48Vdc	62.561	3004
HYD 3000-ES	253Vac	13.017	3257	48Vdc	62.648	3010
HYD 3000-ES	207Vac	15.921	3269	58Vdc	51.543	2993
HYD 3000-ES	230Vac	14.316	3258	58Vdc	51.64	2999
HYD 3000-ES	253Vac	13.079	3271	58Vdc	51.539	2993
Type	U (V)	I (A) DC	P (W) DC	U (V)	I (A) AC	P (W) AC
Battery discharging mode						
HYD 3000-ES	46Vdc	69.983	3222	207Vac/50Hz	14.840	2991
HYD 3000-ES	46Vdc	69.942	3220	230Vac/50Hz	13.451	2990
HYD 3000-ES	46Vdc	69.913	3220	253Vac/50Hz	12.285	2990
HYD 3000-ES	48Vdc	66.811	3222	207Vac/50Hz	14.840	2995
HYD 3000-ES	48Vdc	67.011	3223	230Vac/50Hz	13.444	2998
HYD 3000-ES	48Vdc	67.001	3222	253Vac/50Hz	12.316	2997
HYD 3000-ES	58Vdc	56.432	3245	207Vac/50Hz	15.025	3012
HYD 3000-ES	58Vdc	56.422	3244	230Vac/50Hz	13.65	3019
HYD 3000-ES	58Vdc	56.395	3243	253Vac/50Hz	12.425	3023
HYD 3000-ES	46Vdc	69.985	3221	207Vac/60Hz	14.839	2990
HYD 3000-ES	46Vdc	69.938	3221	230Vac/60Hz	13.450	2989
HYD 3000-ES	46Vdc	69.889	3218	253Vac/60Hz	12.264	2988
HYD 3000-ES	48Vdc	66.809	3221	207Vac/60Hz	14.839	2994
HYD 3000-ES	48Vdc	67.017	3223	230Vac/60Hz	13.439	2998
HYD 3000-ES	48Vdc	67.008	3222	253Vac/60Hz	12.314	2997
HYD 3000-ES	58Vdc	56.435	3245	207Vac/60Hz	15.029	3012
HYD 3000-ES	58Vdc	56.427	3244	230Vac/60Hz	13.650	3019



**BUREAU
VERITAS**

Test Report No: LD190808N030

HYD 3000-ES	58Vdc	56.401	3243	253Vac/60Hz	12.427	3024
Type	U (V)	I (A) DC	P (W) DC	U (V)	I (A) AC	P (W) AC
PV input for battery charging and AC output mode						
HYD 3000-ES	90Vdc	13.289	1185	230Vac/50Hz	0.012	1
HYD 3000-ES				46Vdc	23.011	1060
HYD 3000-ES	160Vdc	19.641	3160	230Vac/50Hz	0.013	2
HYD 3000-ES				46Vdc	62.913	2893
HYD 3000-ES	360Vdc	8.649	3123	230Vac/50Hz	0.012	2
HYD 3000-ES				46Vdc	63.307	2909
HYD 3000-ES	520Vdc	6.089	3157	230Vac/50Hz	0.01	1
HYD 3000-ES				46Vdc	64.282	2950
HYD 3000-ES	580Vdc	0.315	177	230Vac/50Hz	0	0
HYD 3000-ES				46Vdc	2.667	123
HYD 3000-ES	90Vdc	13.238	1186	230Vac/50Hz	0	0
HYD 3000-ES				48Vdc	22.014	1060
HYD 3000-ES	160Vdc	19.374	3144	230Vac/50Hz	0	0
HYD 3000-ES				48Vdc	60.303	2900
HYD 3000-ES	360Vdc	8.670	3125	230Vac/50Hz	0	0
HYD 3000-ES				48Vdc	60.598	2912
HYD 3000-ES	520Vdc	6.001	3125	230Vac/50Hz	0	0
HYD 3000-ES				48Vdc	60.996	2930
HYD 3000-ES	580Vdc	0.312	178	230Vac/50Hz	0.015	3
HYD 3000-ES				48Vdc	2.533	123
HYD 3000-ES	90Vdc	13.255	1186	230Vac/50Hz	0	0
HYD 3000-ES				58Vdc	18.145	1056
HYD 3000-ES	160Vdc	19.768	3165	230Vac/50Hz	0	0
HYD 3000-ES				58Vdc	50.289	2922
HYD 3000-ES	360Vdc	8.843	3193	230Vac/50Hz	0	0
HYD 3000-ES				58Vdc	51.667	3000
HYD 3000-ES	520Vdc	6.088	3157	230Vac/50Hz	0	0
HYD 3000-ES				58Vdc	51.47	2987
HYD 3000-ES	580Vdc	0.32	178	230Vac/50Hz	0	0
HYD 3000-ES				58Vdc	2.061	120
HYD 3000-ES	90Vdc	13.291	1186	230Vac/60Hz	0.012	1
HYD 3000-ES				46Vdc	23.013	1061
HYD 3000-ES	160Vdc	19.642	3161	230Vac/60Hz	0.013	2
HYD 3000-ES				46Vdc	62.915	2891
HYD 3000-ES	360Vdc	8.651	3124	230Vac/60Hz	0.012	2
HYD 3000-ES				46Vdc	63.311	2911
HYD 3000-ES	520Vdc	6.111	3155	230Vac/60Hz	0.01	1
HYD 3000-ES				46Vdc	64.287	2951
HYD 3000-ES	580Vdc	0.317	178	230Vac/60Hz	0	0
HYD 3000-ES				46Vdc	2.669	122
HYD 3000-ES	90Vdc	13.148	1184	230Vac/60Hz	0	0
HYD 3000-ES				48Vdc	22.011	1060
HYD 3000-ES	160Vdc	19.816	3166	230Vac/60Hz	0.015	3
HYD 3000-ES				48Vdc	60.300	2901
HYD 3000-ES	360Vdc	8.669	3125	230Vac/60Hz	0	0
HYD 3000-ES				48Vdc	60.592	2912



HYD 3000-ES	520Vdc	6.035	3129	230Vac/60Hz	0.17	5
HYD 3000-ES				48Vdc	60.990	2929
HYD 3000-ES	580Vdc	0.314	178	230Vac/60Hz	0.015	3
HYD 3000-ES				48Vdc	2.532	123
HYD 3000-ES	90Vdc	13.167	1185	230Vac/60Hz	0	0
HYD 3000-ES				58Vdc	18.156	1056
HYD 3000-ES	160Vdc	19.768	3164	230Vac/60Hz	0	0
HYD 3000-ES				58Vdc	50.279	2923
HYD 3000-ES	360Vdc	8.922	3195	230Vac/60Hz	0	0
HYD 3000-ES				58Vdc	51.662	3000
HYD 3000-ES	520Vdc	6.088	3157	230Vac/60Hz	0	0
HYD 3000-ES				58Vdc	51.462	2987
HYD 3000-ES	580Vdc	0.312	179	230Vac/60Hz	0	0
HYD 3000-ES				58Vdc	2.062	120
supplementary information						

4.3	TABLE: heating temperature rise measurements (PV input for all AC output mode)				P	
	Test voltage (V)	A: 300Vdc/20.7A; 230Vac,25.8A B: 300Vdc/10.7A; 230Vac,13.0A C: 520Vdc/12.1A; 230Vac,26.2A D: 520Vdc/6.15A; 230Vac,13.0A			—	
	t1 (°C)	See below			—	
	t2 (°C)	See below			—	
Temperature T of part/at:		Measured T (°C)			Limit T (°C)	
		A	B	C	D	
	Ambient	45.86	60.61	45.34	60.54	--
	Battery input connector	55.28	62.77	53.00	61.48	120
	PV input line	56.99	62.68	53.34	61.29	105
	Battery input line	55.17	63.31	53.59	62.07	105
	DC switch body	58.39	63.61	55.87	62.45	70
	T2 winding	63.97	67.99	62.67	66.50	110
	R534	66.13	69.19	65.32	67.79	155
	D134	66.06	69.20	65.21	67.79	130
	Q18	86.10	76.50	78.22	72.95	130
	Q17	76.81	73.77	76.82	72.07	130
	Q22	76.77	73.88	77.16	72.27	130
	EC2	66.44	69.43	65.36	67.97	105
	D13	91.62	80.04	88.63	76.51	130
	Q26	105.56	86.89	102.88	84.09	130
	Optocoupler_U2	88.83	79.46	85.54	77.10	100
	R30	85.02	76.45	84.19	76.74	155
	Q25	108.09	87.72	104.83	85.28	130
	Q12	87.43	77.35	87.07	75.88	130
	Q7	86.10	76.83	86.44	75.37	130
	Q6	104.90	84.41	106.65	81.94	130
	Q5	105.10	84.29	107.03	81.27	130
	C13	75.30	72.95	74.74	71.25	105



**BUREAU
VERITAS**

Test Report No: LD190808N030

L8 winding	78.60	73.97	75.25	72.31	105
L8 core	75.68	73.95	75.34	72.10	105
Q8	74.10	73.72	74.85	72.01	130
Q14	76.12	73.55	77.49	71.93	130
C8	73.06	73.61	72.87	71.98	130
Relay RY3 enclosure	75.20	74.17	74.96	72.72	85
T3 body	78.04	75.66	79.75	76.17	130
Power PCB	62.37	66.65	61.00	65.23	130
T1 winding	77.05	78.74	77.74	78.68	110
T1 core	78.15	79.84	79.13	80.05	110
Master DSP	72.42	76.18	71.59	74.59	105
AC connector	58.14	63.54	56.24	62.13	105
AC_L line	62.61	64.98	60.69	63.56	105
Power PCB	64.24	67.10	63.59	65.94	130
PV connector	45.98	60.70	45.88	61.32	90
CF375	64.04	67.00	62.92	65.69	105
DC switch knob	47.65	61.81	46.47	61.11	70
C4	85.10	77.09	82.96	74.48	105
PF18 line	71.07	70.43	69.83	68.77	120
INV L Line	90.75	76.45	92.93	75.59	105
C107	75.54	71.76	73.98	70.01	100
L9 winding	82.01	73.54	80.72	72.01	105
L10 winding	78.60	74.06	76.75	72.39	105
C94	77.17	73.76	75.93	71.93	110
RL3	75.29	72.66	74.27	70.89	85
R297	72.21	71.72	70.77	70.01	155
L8 winding	75.73	69.98	74.81	68.09	105
L15 winding	67.04	66.96	60.78	64.72	105
C142	66.09	67.45	62.32	65.67	105
UC32	69.90	69.73	66.44	68.20	125
Output PCB	97.11	79.76	96.61	77.06	130
INV inductor L line	103.10	81.57	102.99	81.34	105
INV inductor N line	104.06	82.94	103.98	82.18	105
BOOST inductor 1	99.74	83.17	93.08	77.95	105
BOOST inductor 1	98.10	82.43	89.87	77.00	105
Displayer	62.17	65.32	59.72	63.78	75
Mounting bracket	66.04	67.68	66.35	65.77	90

supplementary information:

*The symol 14 of Annex C is marked on the heating sink.



4.3	TABLE: heating temperature rise measurements (PV input for battery charging and AC output mode)				P
	Test voltage (V)	E: 300Vdc/20.6A; 230Vac,12.6A F: 300Vdc/11.0A; 230Vac,13.4A G: 520Vdc/12.0A; 230Vac,13.0A H: 520Vdc/6.2A; 230Vac,13.4A			—
	t1 (°C)	See below			—
	t2 (°C)	See below			—
Temperature T of part/at:	Measured T (°C)				Limit T (°C)
	E	F	G	H	
Ambient	45.73	60.42	45.59	60.29	--
Battery input connector	51.22	64.93	54.17	61.11	120
PV input line	59.89	64.14	55.05	61.54	105
Battery input line	50.30	65.22	53.68	61.14	105
DC switch body	61.78	65.24	57.62	62.81	70
T2 winding	71.61	75.83	58.82	73.80	110
R534	68.98	76.94	58.49	72.83	155
D134	66.00	73.75	57.72	71.73	130
Q18	69.14	78.26	56.73	73.19	130
Q17	73.88	80.39	58.50	74.67	130
Q22	73.94	79.68	59.22	75.14	130
EC2	65.85	75.03	58.27	73.11	105
D13	88.84	83.98	62.91	75.77	130
Q26	102.35	91.11	60.97	75.31	130
Optocoupler_U2	86.09	83.72	62.56	76.24	100
R30	82.62	91.75	64.23	84.59	155
Q25	111.17	92.14	62.43	75.93	130
Q12	84.50	83.31	63.02	77.62	130
Q7	83.48	89.80	64.61	80.48	130
Q6	108.40	83.87	78.37	82.92	130
Q5	108.10	82.27	78.54	82.47	130
C13	79.40	74.63	63.30	74.20	105
L8 winding	73.54	77.39	63.95	76.73	105
L8 core	73.81	77.12	64.43	77.04	105
Q8	71.30	79.60	59.79	76.93	130
Q14	73.25	79.36	60.82	77.02	130
C8	76.60	76.98	61.12	76.05	130
Relay RY3 enclosure	82.60	76.44	62.64	75.85	85
T3 body	81.48	76.84	67.95	80.16	130
Power PCB	60.04	71.85	53.20	68.75	130
T1 winding	80.81	80.45	69.04	81.87	110
T1 core	81.95	81.60	70.61	83.54	110
Master DSP	75.93	78.36	70.66	76.70	105
AC connector	62.05	63.69	57.13	63.00	105
AC_L line	66.58	65.13	59.88	64.16	105
Power PCB	61.83	72.98	54.16	68.20	130
PV connector	46.26	60.72	47.30	60.51	90
CF375	61.54	69.99	62.14	68.88	105
DC switch knob	46.67	62.09	48.00	60.57	70
C4	88.86	77.30	75.25	75.85	105



**BUREAU
VERITAS**

Test Report No: LD190808N030

PF18 line	68.56	76.02	57.62	72.82	120
INV L Line	93.73	74.91	77.52	76.69	105
C107	79.15	71.89	68.84	71.94	100
L9 winding	85.35	73.36	72.44	73.91	105
L10 winding	81.26	73.72	70.66	74.00	105
C94	79.93	73.27	70.49	74.00	110
RL3	79.19	73.47	68.32	72.01	85
R297	75.36	71.79	67.27	71.40	155
L8 winding	79.14	69.08	66.82	69.95	105
L15 winding	77.28	68.30	60.08	65.69	105
C142	69.78	68.51	62.16	66.93	105
UC32	73.43	71.56	63.87	70.19	125
Output PCB	99.37	77.44	80.13	78.82	130
INV inductor L line	103.23	78.74	85.88	81.95	105
INV inductor N line	102.79	80.48	86.80	84.23	105
BOOST inductor 1	104.15	83.98	78.64	82.90	105
BOOST inductor 1	102.51	84.73	77.26	81.27	105
Displayer	65.28	66.03	59.32	65.46	75
Mounting bracket	68.74	69.23	56.36	69.58	90

supplementary information:

*The symol 14 of Annex C is marked on the heating sink.



**BUREAU
VERITAS**

Test Report No: LD190808N030

4.3	TABLE: heating temperature rise measurements (AC charging mode)				P
	Test voltage (V)	I: 207Vac/15.7A;48V/63A J: 207Vac/9.5A;48V/45A K: 253Vac/13.1A;48V/63A L: 253Vac/8.0A;48V/45A			—
	t1 (°C)	See below			—
	t2 (°C)	See below			—
Temperature T of part/at:	Measured T (°C)				Limit T (°C)
	I	J	K	L	
Ambient	45.02	60.85	45.04	60.14	--
Battery input connector	54.55	61.86	52.59	61.71	120
PV input line	52.23	62.39	52.62	61.89	105
Battery input line	59.11	62.77	52.00	62.49	105
DC switch body	55.68	63.47	55.88	63.25	70
T2 winding	70.48	77.52	67.06	73.84	110
R534	77.65	80.31	65.95	73.67	155
D134	72.17	73.81	65.03	72.03	130
Q18	79.50	73.92	62.48	73.65	130
Q17	81.60	74.39	63.34	74.39	130
Q22	81.39	74.24	63.64	74.14	130
EC2	70.82	74.76	66.37	73.01	105
D13	72.99	72.13	63.25	72.03	130
Q26	74.14	72.58	64.00	72.62	130
Optocoupler_U2	77.74	73.61	67.19	73.92	100
R30	89.52	82.05	70.67	83.20	155
Q25	73.59	72.24	63.96	72.11	130
Q12	77.30	74.53	64.82	74.59	130
Q7	95.60	82.23	66.31	82.26	130
Q6	81.14	75.50	65.94	75.10	130
Q5	78.92	74.92	64.80	74.42	130
C13	71.05	71.75	69.21	72.08	105
L8 winding	78.27	74.36	71.75	74.65	105
L8 core	77.58	73.91	72.85	74.57	105
Q8	75.77	76.35	66.17	76.19	130
Q14	76.52	75.84	65.45	75.62	130
C8	72.66	74.91	67.77	75.07	130
Relay RY3 enclosure	71.96	74.42	67.41	74.63	85
T3 body	72.56	76.35	70.16	77.06	130
Power PCB	73.63	69.38	61.10	69.58	130
T1 winding	73.76	79.28	73.47	80.11	110
T1 core	75.11	80.32	74.96	81.39	110
Master DSP	70.09	76.96	67.91	77.22	105
AC connector	52.78	64.02	51.75	63.32	105
AC_L line	55.18	64.82	53.42	64.19	105
Power PCB	90.01	69.03	60.87	69.76	130
PV connector	45.43	61.23	45.92	60.51	90
CF375	83.15	68.09	64.27	68.23	105
DC switch knob	45.64	61.06	45.66	61.57	70
C4	72.52	71.10	70.24	71.51	105



**BUREAU
VERITAS**

Test Report No: LD190808N030

PF18 line	105.34	71.81	64.57	72.04	120
INV L Line	72.86	71.23	65.98	71.13	105
C107	67.00	69.22	65.67	69.70	100
L9 winding	69.37	70.62	66.65	71.18	105
L10 winding	68.80	72.10	66.75	72.63	105
C94	68.19	72.30	66.46	72.98	110
RL3	67.69	71.13	64.06	71.58	85
R297	65.51	70.66	64.31	70.99	155
L8 winding	63.22	67.87	59.94	68.05	105
L15 winding	58.31	65.91	58.54	66.02	105
C142	60.46	66.89	60.92	67.11	105
UC32	64.76	69.09	62.72	69.27	125
Output PCB	74.70	75.19	68.98	75.53	130
INV inductor L line	78.35	73.64	70.02	73.47	105
INV inductor N line	79.44	73.89	71.79	74.02	105
BOOST inductor 1	77.11	73.30	73.58	73.93	105
BOOST inductor 2	77.15	73.54	73.70	74.07	105
Displayer	58.77	65.64	58.45	65.84	75
Mounting bracket	62.44	69.26	57.68	68.71	90

supplementary information:

*The symol 14 of Annex C is marked on the heating sink.



4.3	TABLE: heating temperature rise measurements (Battery discharging mode)				P
	Test voltage (V)	M: 46Vdc/70A;230Vac/13.5A N: 46Vdc/45.0A;230Vac/9.5A O: 58Vdc/56A;230Vac/14.0A P: 58Vdc/37A; 230Vac/9.0A			—
	t1 (°C)	See below			—
	t2 (°C)	See below			—
Temperature T of part/at:	Measured T (°C)				Limit T (°C)
	M	N	O	P	
Ambient	45.51	60.12	45.07	60.03	--
Battery input connector	47.55	63.78	59.30	62.00	120
PV input line	47.29	62.15	54.93	62.24	105
Battery input line	47.34	65.43	64.97	63.21	105
DC switch body	48.54	63.60	57.89	63.19	70
T2 winding	62.28	77.09	74.19	74.52	110
R534	63.11	79.94	84.66	76.30	155
D134	61.83	78.40	76.60	73.63	130
Q18	50.83	77.99	84.92	76.78	130
Q17	50.71	78.89	86.96	77.93	130
Q22	50.98	79.63	87.07	78.62	130
EC2	59.27	74.50	74.39	73.49	105
D13	50.43	73.51	74.56	72.88	130
Q26	50.77	74.14	75.95	73.59	130
Optocoupler_U2	52.35	76.81	83.01	76.49	100
R30	52.29	86.64	89.36	84.08	155
Q25	50.58	74.94	75.88	74.26	130
Q12	50.80	87.15	96.72	85.43	130
Q7	51.25	81.06	87.55	79.84	130
Q6	51.65	77.15	81.30	77.02	130
Q5	51.10	76.17	80.09	75.88	130
C13	55.57	71.17	73.03	71.87	105
L8 winding	55.96	75.61	81.92	75.91	105
L8 core	56.49	75.29	81.33	75.80	105
Q8	52.67	74.58	74.03	73.53	130
Q14	51.27	74.01	73.99	73.14	130
C8	54.84	73.33	73.68	73.28	130
Relay RY3 enclosure	54.52	72.82	72.34	73.06	85
T3 body	53.46	73.14	71.65	74.92	130
Power PCB	51.65	73.30	81.74	72.65	130
T1 winding	59.43	77.27	74.58	78.86	110
T1 core	60.25	78.44	76.15	80.14	110
Master DSP	59.50	75.62	71.51	76.34	105
AC connector	47.46	62.63	54.36	63.28	105
AC_L line	48.20	63.71	56.92	64.05	105
Power PCB	50.71	76.36	89.99	75.06	130
PV connector	46.27	60.97	45.90	60.97	90
CF375	50.47	73.61	82.89	72.51	105
DC switch knob	45.78	61.95	45.96	61.05	70



**BUREAU
VERITAS**

Test Report No: LD190808N030

C4	56.79	70.79	73.98	72.30	105
PF18 line	51.30	83.20	106.95	81.33	120
INV L Line	51.79	70.32	72.62	70.99	105
C107	53.80	68.55	68.82	68.98	100
L9 winding	54.59	69.85	70.86	70.43	105
L10 winding	54.46	70.48	69.91	71.72	105
C94	53.19	70.93	69.68	72.26	110
RL3	51.23	71.46	70.08	71.60	85
R297	54.05	69.75	66.94	70.35	155
L8 winding	50.91	66.51	64.60	67.44	105
L15 winding	50.52	65.00	59.93	65.29	105
C142	51.94	65.78	62.02	66.30	105
UC32	52.45	68.58	66.66	68.56	125
Output PCB	53.46	73.58	75.23	74.49	130
INV inductor L line	52.59	73.97	76.10	74.01	105
INV inductor N line	53.39	75.28	78.27	75.17	105
BOOST inductor 1	54.41	75.82	78.01	75.25	105
BOOST inductor 2	54.20	76.24	78.35	75.68	105
Displayer	49.73	64.21	60.42	65.19	75
Mounting bracket	48.54	66.86	61.46	67.63	90

supplementary information:

*The symol 14 of Annex C is marked on the heating sink.



4.4		TABLE: fault condition tests						P
		ambient temperature (°C) : 24.6						—
component No.	fault	test condition		test time	fuse No.	fault condition		result
		AC	DC			AC	DC	
Relay RY1 defect	Short circuit before energized	230V 0.02A	520V 0.02A	3Min.	--	230V 0.02A	520V 0.02A	Indicate Relay fault, error code "ID55" (RecoverRelayFail). Do not connect to AC mainsn. No damage, no hazards.
Relay RY2 defect	Short circuit before energized	230V 0.02A	520V 0.02A	3Min.	--	230V 0.02A	520V 0.02A	Indicate Relay fault, error code "ID55" (RecoverRelayFail). Do not connect to AC mainsn. No damage, no hazards.
Relay RY3 defect	Short circuit before energized	230V 0.02A	520V 0.02A	3Min.	--	230V 0.02A	520V 0.02A	Indicate Relay fault, error code "ID55" (RecoverRelayFail). Do not connect to AC mainsn. No damage, no hazards.
Relay RY4 defect	Short circuit before energized	230V 0.02A	520V 0.02A	3Min.	--	230V 0.02A	520V 0.02A	Indicate Relay fault, error code "ID55" (RecoverRelayFail). Do not connect to AC mainsn. No damage, no hazards.
Relay RY5 defect	Short circuit before energized	230V 0.02A	520V 0.02A	3Min.	--	230V 0.02A	520V 0.02A	Indicate Relay fault, error code "ID55" (RecoverRelayFail). Do not connect to AC mainsn. No damage, no hazards.
Relay RY6 defect	Short circuit before energized	230V 0.02A	520V 0.02A	3Min.	--	230V 0.02A	520V 0.02A	Indicate Relay fault, error code "ID55" (RecoverRelayFail). Do not connect to AC mainsn. No damage, no hazards.
Monitoring voltage defect R508	short	230V 26.2A	520V 12.1A	3Min.	--	230V 0.02A	520V 0.02A	Output a.c. relays operated, disconnected with grid. Q59 damage. No hazards.
Monitoring voltage defect Q59 pin 1-2	short	230V 26.2A	520V 12.1A	3Min.	--	230V 0.02A	520V 0.02A	Output a.c. relays operated, disconnected with grid , error code "ID55" (RecoverRelayFail). No damage, no hazards.
Monitoring voltage defect U46 pin 1-2	short	230V 26.2A	520V 12.1A	3Min.	--	230V 0.02A	520V 0.02A	Output a.c. relays operated, disconnected with grid , error code "ID55" (RecoverRelayFail). U46 damage, no hazards.



**BUREAU
VERITAS**

Test Report No: LD190808N030

component No.	fault	test condition		test time	fuse No.	fault condition		result
		AC	DC			AC	DC	
Monitoring voltage defect R511	short	230V 26.2A	520V 12.1A	3Min.	--	230V 0.02A	520V 0.02A	Output a.c. relays operated, disconnected with grid , error code "ID55" (RecoverRelayFail). U46 damage, no hazards.
Monitoring voltage defect R509	open	230V 26.2A	520V 12.1A	3Min.	--	230V 0.02A	520V 0.02A	The unit was in check state. No damage. No hazards.
Monitoring voltage defect U46 pin 3-4	short	230V 26.2A	520V 12.1A	3Min.	--	230V 0.02A	520V 0.02A	Output a.c. relays operated, disconnected with grid , error code "ID55" (RecoverRelayFail). U46 damage, no hazards.
Voltage measurement disabled R204	Open	230V 26.2A	520V 12.1A	3Min.	--	230V 0.02A	520V 0.02A	Output a.c. relays operated, disconnected with grid , error code "ID01" (The grid voltage is too high). No damage. No hazards.
L to N (grid)	Short circuit	230V 26.2A	520V 12.1A	3Min.	--	0V 0A	520V 0.02A	Output a.c. relays operated, disconnected with grid. No damage. No hazards.
PV+ to PV-	Short circuit	230V 0.02A	520V 0.02A	3Min.	--	230V 0.02A	520V 0.02A	Output a.c. relays operated, disconnected with grid. No damage. No hazards.
L to N (off-grid)	Short circuit	230V 14.0A	58V 56.4A	3Min.	--	0V 0A	58V 0.1A	No damage. No hazards.
L to N (off-grid)	Over load	230V 14.0A	58V 56.4A	3Min.	--	0V 0A	58V 0.1A	The EUT shut down immediately, indicate over current, error code "over load". No damage, no hazards.
PV+ to PV-	Reverse d	230V 0.02A	520V 0.02A	3Min.	--	230V 0.02A	520V 0.02A	Do not connect to AC mains, can reset by remove fault condition. No damage, no hazards.
BAT+ to BAT-	Reverse d	230V 0.02A	520V 0.02A	3Min.	--	230V 0.02A	520V 0.02A	Battery did not join to the system. No damage, no hazards.
L to N(grid)	Reverse d	230V 0.02A	500V 0.02A	3Min.	--	230V 0.02A	500V 0.02A	EUT operationed normally. No damage, no hazards.
Loss of control XL1	Short	230V 26.2A	520V 12.1A	3Min.	--	230V 0.02A	520V 0.02A	Output a.c. relays operated, disconnected with grid , error code "ID53, ID54" (SPI communication is fault, SCI communication is fault). No damage. No hazards.



component No.	fault	test condition		test time	fuse No.	fault condition		result
		AC	DC			AC	DC	
Loss of control C738(3.3VDD)	Short	230V 26.2A	520V 12.1A	3Min.	--	230V 0.02A	520V 0.02A	Output a.c. relays operated, disconnected with grid , error code "ID53, ID54" (SPI communication is fault, SCI communication is fault). No damage. No hazards.
Communication microcontroller defect U4 pin1 to pin2	Short	230V 26.2A	520V 12.1A	3Min.	--	230V 0.02A	520V 0.02A	Output a.c. relays operated, disconnected with grid , error code "ID53, ID54, ID75" (SPI communication is fault, SCI communication is fault, Unrecoverable EEPROM write). No damage. No hazards.
ISO defect R531	Short circuit before energized	230V 26.2A	520V 12.1A	3Min.	--	230V 0.02A	520V 0.02A	Indicate ISO fault, error code "ID56" (The insulation resistance is too low). Do not connect to AC mainsn. No damage, no hazards.
ISO defect R598	Open circuit before energized	230V 0.02A	520V 0.02A	3Min.	--	230V 0.02A	520V 0.02A	Indicate ISO fault, error code "ID56" (The insulation resistance is too low). Do not connect to AC mainsn. No damage, no hazards.
ISO defect R602	Short circuit before energized	230V 0.02A	520V 0.02A	3Min.	--	230V 0.02A	520V 0.02A	Indicate ISO fault, error code "ID56" (The insulation resistance is too low). Do not connect to AC mainsn. No damage, no hazards.
ISO defect R605	Open circuit before energized	230V 0.02A	520V 0.02A	3Min.	--	230V 0.02A	520V 0.02A	Indicate ISO fault, error code "ID56" (The insulation resistance is too low). Do not connect to AC mainsn. No damage, no hazards.
ISO defect R355	Short circuit before energized	230V 0.02A	520V 0.02A	3Min.	--	230V 0.02A	520V 0.02A	Indicate ISO fault, error code "ID56" (The insulation resistance is too low). Do not connect to AC mainsn. No damage, no hazards.
ISO defect R303	Open circuit before energized	230V 0.02A	520V 0.02A	3Min.	--	230V 0.02A	520V 0.02A	Indicate ISO fault, error code "ID56" (The insulation resistance is too low). Do not connect to AC mainsn. No damage, no hazards.
ISO defect R307	Short circuit before energized	230V 0.02A	520V 0.02A	3Min.	--	230V 0.02A	520V 0.02A	Indicate ISO fault, error code "ID56" (The insulation resistance is too low). Do not connect to AC mainsn. No damage, no hazards.



component No.	fault	test condition		test time	fuse No.	fault condition		result
		AC	DC			AC	DC	
ISO defect U23 pin 13-14	Short circuit before energized	230V 0.02A	520V 0.02A	3Min.	--	230V 0.02A	520V 0.02A	Indicate ISO fault, error code "ID56" (The insulation resistance is too low). Do not connect to AC mainsn. No damage, no hazards.
GFCI defect R292	Open	230V 26.2A	520V 12.1A	3Min.	--	230V 0.02A	520V 0.02A	Indicate GFCI fault, error code "ID48" (The GFCI sampling value between the master DSP and slave DSP is not consistent). Do not connect to AC mainsn. No damage, no hazards.
GFCI defect R297	Open	230V 26.2A	520V 12.1A	3Min.	--	230V 0.02A	520V 0.02A	Indicate GFCI fault, error code "ID48" (The GFCI sampling value between the master DSP and slave DSP is not consistent). Do not connect to AC mainsn. No damage, no hazards.
T2 pin 1-3	Short	230V 26.2A	520V 12.1A	3Min.	--	230V 0.02A	520V 0.02A	The EUT shut down immediately.The displayer was not work. No damage, no hazards.
T2 pin 5-6	Short	230V 26.2A	520V 12.1A	3Min.	--	230V 0.02A	520V 0.02A	The EUT shut down immediately.The displayer was not work. No damage, no hazards.
T2 pin8-7	Short	230V 26.2A	520V 12.1A	3Min.	--	230V 0.02A	520V 0.02A	The EUT shut down immediately.The displayer was not work. D84 damaged, no hazards.
T2 pin12-10	Short	230V 26.2A	520V 12.1A	3Min.	--	230V 0.02A	520V 0.02A	The EUT shut down immediately.The displayer was not work. D86, D134 Ddamaged, no hazards.
Q12 pin D-S	Short	230V 26.2A	520V 12.1A	3Min.	--	230V 0.02A	520V 0.02A	The EUT shut down immediately, output a.c. relays operated, disconnected with grid. Q12 damaged. No hazards.
Q23 pin D-S	Short	230V 26.2A	520V 12.1A	3Min.	--	230V 0.02A	520V 0.02A	The EUT shut down immediately, output a.c. relays operated, disconnected with grid. Q23 damaged. No hazards.



component No.	fault	test condition		test time	fuse No.	fault condition		result
		AC	DC			AC	DC	
Q16 pin D-S	Short	230V 26.2A	520V 12.1A	3Min.	--	230V 0.02A	520V 0.02A	The EUT shut down immediately, output a.c. relays operated, disconnected with grid. Q16 damaged. No hazards.
Q21 pin D-S	Short	230V 26.2A	520V 12.1A	3Min.	--	230V 0.02A	520V 0.02A	The EUT shut down immediately, output a.c. relays operated, disconnected with grid. Q21 damaged. No hazards.
Q7 pin D-S	Short	230V 26.2A	520V 12.1A	3Min.	--	230V 0.02A	520V 0.02A	The EUT shut down immediately, output a.c. relays operated, disconnected with grid. Q7 damaged. No hazards.
Q9 pin D-S	Short	230V 26.2A	520V 12.1A	3Min.	--	230V 0.02A	520V 0.02A	The EUT shut down immediately, output a.c. relays operated, disconnected with grid. Q9,Q13 damaged. No hazards.
Q13 pin D-S	Short	230V 26.2A	520V 12.1A	3Min.	--	230V 0.02A	520V 0.02A	The EUT shut down immediately, output a.c. relays operated, disconnected with grid. Q9,Q13 damaged. No hazards.
Q4 pin D-S	Short	230V 26.2A	520V 12.1A	3Min.	--	230V 0.02A	520V 0.02A	The EUT shut down immediately, output a.c. relays operated, disconnected with grid. Q1,Q2,Q3,Q6 damaged. No hazards.
Q6 pin D-S	Short	230V 26.2A	520V 12.1A	3Min.	--	230V 0.02A	520V 0.02A	The EUT shut down immediately, output a.c. relays operated, disconnected with grid. Q1,Q2,Q3,Q6 damaged. No hazards.
See technical documentation.								

4.7.4.2 & 4.7.4.3 TABLE: mains supply electrical data in normal condition						P
Model	U (V) DC	I (A) DC	P (kW) DC	P (kW) AC	I(A) AC	U (V) AC (off-grid port))
HYD 6000-ES	46Vdc	0.33	0.02	No-load	--	233.2
	48Vdc	0.33	0.02	No-load	--	233.2
	58Vdc	0.33	0.02	No-load	--	233.2
	46Vdc	69.945	3.219	2.992	13.459	222.3



	48Vdc	66.998	3.222	2.998	13.447	223.0
	58Vdc	56.415	3.245	3.019	13.990	215.9
Supplementary information:						

4.7.4.4 TABLE: mains supply electrical data in normal condition						P
Model	U (V) DC	I (A) DC	P (kW) DC	P (kW) AC	I(A) AC	U (V) AC (off-grid port)
HYD 6000-ES	48	--	--	0 – 100%	--	224.8
	48	--	--	100%-0	--	233.2
Supplementary information						

4.7.4.5 TABLE: mains supply electrical data in normal condition							P
Model	U (V) DC	I (A) DC	P (kW) DC	P (kW) AC	I(A) AC	U (V) AC(off-grid port)	F (Hz) AC (off-grid port)
HYD 6000-ES	46Vdc	0.33	0.02	No-load	--	233.2	50.00
	48Vdc	0.33	0.02	No-load	--	233.2	50.00
	58Vdc	0.33	0.02	No-load	--	233.2	50.00
	46Vdc	69.945	3.219	2.992	13.459	222.3	50.00
	48Vdc	66.998	3.222	2.998	13.447	223.0	50.00
	58Vdc	56.415	3.245	3.019	13.990	215.9	50.00
	46Vdc	0.33	0.02	No-load	--	233.2	60.01
	48Vdc	0.33	0.02	No-load	--	233.2	60.01
	58Vdc	0.33	0.02	No-load	--	233.2	60.01
	46Vdc	69.951	3222	2989	14.851	201.3	60.01
	48Vdc	66.995	3222	2998	13.449	222.9	60.01
	58Vdc	56.409	3245	3019	14.003	215.6	60.01
Supplementary information:							

4.7.5.2 TABLE: Harmonics and inter-harmonics (u)				P
Harmon. Nr.(U)	P/Prated			Limit
	5%	50%	100%	
2	0.038	0.038	0.015	6%
3	0.920	0.920	1.958	6%
4	0.031	0.031	0.007	6%
5	0.270	0.270	0.921	6%
6	0.019	0.019	0.009	6%
7	0.707	0.707	0.624	6%
8	0.027	0.027	0.007	6%



**BUREAU
VERITAS**

Test Report No: LD190808N030

9	0.244	0.244	0.465	6%
10	0.013	0.013	0.008	6%
11	0.084	0.084	0.369	6%
12	0.011	0.011	0.007	6%
13	0.244	0.244	0.297	6%
14	0.011	0.011	0.007	6%
15	0.314	0.314	0.253	6%
16	0.010	0.010	0.007	6%
17	0.196	0.196	0.208	6%
18	0.009	0.009	0.007	6%
19	0.250	0.250	0.184	6%
20	0.010	0.010	0.008	6%
21	0.327	0.327	0.155	6%
22	0.012	0.012	0.008	6%
23	0.265	0.265	0.135	6%
24	0.014	0.014	0.007	6%
25	0.261	0.261	0.121	6%
26	0.021	0.021	0.008	6%
27	0.301	0.301	0.097	6%
28	0.020	0.020	0.007	6%
29	0.289	0.289	0.090	6%
30	0.026	0.026	0.008	6%
31	0.226	0.226	0.078	6%
32	0.025	0.025	0.008	6%
33	0.234	0.234	0.066	6%
34	0.026	0.026	0.007	6%
35	0.213	0.213	0.051	6%
36	0.021	0.021	0.008	6%
37	0.158	0.158	0.045	6%
38	0.020	0.020	0.007	6%
39	0.142	0.142	0.044	6%
40	0.018	0.018	0.007	6%
THD (2-40)	1.539	1.871	2.397	10%



Supplementary information:

7.3.7	TABLE: clearance and creepage distance measurements					P
clearance cl and creepage distance dcr at / of:	Up (V)	U r.m.s. (V)	required cl (mm)	cl (mm)	required dcr (mm)	dcr (mm)
Primary circuits to secondary circuits on PCB board (RI)	--	230	5.5	6.20	5.5	6.20
Optocoupler pin 1 to pin 3 on PCB board (RI) (U15,U14, U20, U16, U17, U18, U19, U30)	--	230	5.5	7.70	5.5	7.70
Primary circuits to secondary circuits on PCB board (RI)	600	--	6.4	7.60	6.4	7.60
Primary circuits to earthing on PCB board (BI)	600	--	3.2	5.50	3.2	5.50
Y capacitor (C132, C137, C141, C141) to earthing on PCB board (BI)	600	--	3.2	5.50	3.2	5.50
Relay (RY3- RY6) two polarity on PCB board (BI)	600	--	3.2	3.30	3.2	3.30
Y capacitor (C104,C114, C105, C113) to earthing on PCB board (BI)	--	230	3.0	5.50	3.0	5.50
Y capacitor (C105,C113,C97,C92) to earthing on PCB board (BI)	--	230	3.0	5.50	3.0	5.50
Y capacitor (C30, C31) to earthing on PCB board (BI) (Main board)	600	--	3.2	5.50	4.5	5.50
Primary circuits to earthing on PCB board (BI) (Main board)	600	--	3.2	5.50	3.2	5.50

Supplementary information:
 RI: Reinforced insulation, DI: double insulation, BI: basic insulation, SI: supplementary insulation
 The double side PCB layout is considered and evaluated.

7.3.7.8.3.2 to 7.3.7.8.3.3	TABLE: distance through insulation measurement				P
distance through insulation distance at/of:	U r.m.s. (V)	test voltage (Vdc)	required di (mm)	di (mm)	
Insulation sheet	600	4594	--	0.13	
Photo coupler (certified)*	600	4594	0.2	0.4	

* Approved components.

7.5	TABLE: electric strength measurements, impulse voltage test and partial discharge test			P
test voltage applied between:	test voltage (V)	impulse withstand voltage (V)	partial discharge extinction voltage (V)	result
DC input terminal to earthed enclosure	2545	4000	—	Pass
AC Output terminal to communication port	4240	6000	—	Pass



7.5 TABLE: electric strength measurements, impulse voltage test and partial discharge test				P
test voltage applied between:	test voltage (V)	impulse withstand voltage (V)	partial discharge extinction voltage (V)	result
DC input terminal to communication port	4594	6000	—	Pass
Battery terminal to earthed enclosure	2545	4000	—	Pass
Battery terminal to communication port	4594	6000	—	Pass
Insulation sheet	2545	4000	—	Pass
One layer of insulation tape	4594	6000	—	Pass
Relay pin 3 to pin 4	2545	4000	—	Pass

14 TABLE: list of critical components					P
Component	Manufacturer/ trademark	Type/model	Value / rating	Standard	Approval/ Reference
Metal Enclosure	All	All accepted	Min. thickness : 1.2mm	--	--
Heat-sink (the rear side of enclosure)	All	All accepted	Metal, overall measured: L: 445mm, W: 340mm, H: 57.5mm	--	--
DC breaker	Santon	XBE3310-2-D	650V dc, 25A dc, Max.70°C	EN 60947-3/A1/C1	DEKRA: 2199573.01
Or	ProJoy Electric SRL.	PEDS150R-HM25-3	25A, 600VDC, Max.75°C	EN 60947-3:2009+A1	TUV R50389807
PV connector	Amphenol Industrial operations	Helios H4 series	1000Vdc, 40A, Max. 90°C, IP68	DIN V VDE V 0126-3/12.2006	TUV R 50157783
Or	PV-FT-CF-C; PV-FT-CM-C	Phoenix Contact GmbH & Co.kg	1000Vdc, 40A, Max.85°C, IP65	EN 50521:2008	TUV R 60029159
Or	MC4 Series	Stäubli Electrical Connectors Ltd.	1000Vdc, 39A, Max. 90°C, IP68	EN 50521:2008	TUV R 60028286 R 60087448
Or	H4-RH Bulkhead	Amphenol Technology Co., Ltd	1000Vdc, 39A, Max. 90°C, IP68	EN 50521	TUV 17011847012
Battery terminal	SHENZHEN SUCCEED ELECTRONICS TECHNOLOGY CO.,LTD	TR100-01-2P	AC600V, 100A, Max. 120°C	UL 1059, UL 486E	UL E332956



14 TABLE: list of critical components					P
Component	Manufacturer/ trademark	Type/model	Value / rating	Standard	Approval/ Reference
Internal wiring (DC-in)	ALL	ALL accepted	Min.8AWG,600 V,105°C,VW-1	UL 758	UL
Internal wiring (AC-out)	ALL	ALL accepted	Min.12AWG,60 0V,105°C,VW-1	UL 758	UL
Earthing wire	All	ALL accepted	Min. 12AWG, 600V, 105°C, VW-1	UL 1015	UL
Battery wire	ALL	ALL accepted	Min.8AWG, 600V, 105°C, VW-1	UL 1015	UL
AC Grid terminal	SHENZHEN SUCCEED ELECTRONICS TECHNOLOGY CO.,LTD	TR-6N-01-NP - XX-T(f)	600V, 50A, Max. 105°C	UL 1059, UL 486E	UL E332956
Plastic sheet for Transistors	BERGQUIST CO	K-10#	150°C, VTM-0, min. 0.13mm thickness	UL 94	UL E59150
All PCB	All	All accepted	Min.130°C, min. V-0, CTI≥175	UL 796	UL
LCD panel	MACDERMID AUTOTYPE LTD	Autotex XE(f2)	105°C, V-0, min. 0.2mm thickness	UL 94 UL 746C	UL E165805
Boost inductor (L1, L2)	Huizhou Baohui Electronics Technology Co., Ltd	SH-L1,2,3	0.84mH, Class B	--	--
- Lead wire	All	All accepted	10AWG, 600V, 105°C, VW-1	UL 758	UL
Inductor (L4, L5, TX1)	Huizhou Baohui Electronics Technology Co., Ltd	SH-T016	840μH, ClassB	--	--
- Lead wire	All	All accepted	10AWG, 600V, 105°C, VW-1	UL 758	UL
Inductor (L8, L9, L14, L15)	Huizhou Baohui Electronics Technology Co., Ltd	SH-L040	0.5mH, ClassB	--	--
-Winding	All	All accepted	155°C	UL 1446	UL



14 TABLE: list of critical components					P
Component	Manufacturer/ trademark	Type/model	Value / rating	Standard	Approval/ Reference
-Expoxy	DONGGUAN EATTO ELECTRONIC MATERIAL CO LTD	3300A-1/B-1	V-0, 130°C	UL 746 UL94	UL E218090
SPS transformer (T1)	Huizhou Baohui Electronics Technology Co., Ltd	SH-T008	Class B	--	--
-Winding	All	All accepted	130°C	UL 1446	UL
--Tape	JINGJIANG YAHUA PRESSURE SENSITIVE GLUE CO LTD	CT-	130°C	UL 510	UL E165111
- Margin Tape	Jingjiang Yahua Pressure Sensitive Glue Co Ltd	WF-	130°C	UL 510	UL E165111
-Expoxy	DONGGUAN EATTO ELECTRONIC MATERIAL CO LTD	3300A-1/B-1	V-0, 130°C	UL 746 UL94	UL E218090
Transformer (TX2,T3)	Huizhou Baohui Electronics Technology Co., Ltd	SH-T010	Class B	--	--
-Winding	All	All accepted	130°C	UL 1446	UL
- Bobbin	CHANG CHUN PLASTICS CO LTD	PM-9820 PM-9830	V-0, min. thickness: 0.75mm, 150°C	UL 94	UL E41429
- Margin Tape	Jingjiang Yahua Pressure Sensitive Glue Co Ltd	CT-	130°C	UL 510	UL E165111
BUS Capacitor (C1, C2, C3, C4, C7, C8, C9, C10)	Unielecs Co.,LTD	LLN2F102M355 0	1000µf, 315V, Max.105°C	--	--



14 TABLE: list of critical components					P
Component	Manufacturer/ trademark	Type/model	Value / rating	Standard	Approval/ Reference
Or	Nichicon Co., Ltd.	LGX2F102MEL EZS	1000µf, 315V, Max.105°C	--	--
Or	Nantong jianghai Capacitor Co., Ltd.	ECS2FBB102M VN350050V	1000µf, 315V, Max.105°C	--	--
Or	LELON ELECTRONICS CORP.	LSK102M2F-- A3550	1000µf, 315V, Max.105°C	--	--
DC-LINK Capacitor (C13)	Xiamen FARA Electronic Co.,Ltd	C3D2H606KF0 AC00	60µF, 500V, 105°C	EN61071:2007; EN61881- 1:2011	TUV R 50266108
Y capacitor (C30,C31,C337)	Shantou High- New Technology Dev. Zone Songtian Enterprise Co., Ltd	CE	10nF, 250Vac, Max.125°C	EN 60384- 14:2013; IEC 60384-14(ed.4)	VDE 40025748
Y capacitor (C20,C92,C97, C104,C105,C10 6,C113,C114,C 115,C132,C134, C137,C138,C14 1,C142,C147,C 148)	Shantou High- New Technology Dev. Zone Songtian Enterprise Co., Ltd	CD	Y1, 4.7nF, 400Vac, Max.125°C	EN 60384- 14:2013; IEC 60384-14(ed.4)	VDE 40025754
X2 capacitor (C103,C112)	Shantou High- New Technology Dev. Zone Songtian Enterprise Co., Ltd	MPX	1µF, 275V, Max.110 °C	EN 60384- 14:2013; IEC 60384-14(ed.4)	VDE 40034679
Current transducer (HL1)	LEM	CASR 25-NP	I _{PN} : ±25A; V _{out} : ±5V Max.: 85°C	--	--
IGBT (Q1, Q2, Q3, Q4, Q5, Q6, Q7, Q12, Q25, Q26)	Fairchild Semiconductor Corporation	FGA40N65SMD	650V, 40A, 155°C	--	--



**BUREAU
VERITAS**

Test Report No: LD190808N030

14 TABLE: list of critical components					P
Component	Manufacturer/ trademark	Type/model	Value / rating	Standard	Approval/ Reference
Or	Fairchild Semiconductor Corporation	FGA60N65SMD	650V, 60A, 155°C	--	--
Or	ST Microelectronics	STGWT40H65D FB	650V, 40A, 155°C	--	--
Or	IXYS CORPORATIO N	IXXH40N65B4H 1	650V, 40A, 155°C	--	--
Or	ST Semiconductor Corporation	STGWT60H65D FB	650V, 60A, Max.150°C	--	--
IGBT (QD1, QD2, QD3, QD4)	Infineon Semiconductor Corporation	IKW40N65H5	650V, 46A, 155°C	--	--
MOSFET (Q16, Q17, Q18, Q19, Q21, Q22, Q23, Q24)	Fairchild Semiconductor Corporation	FDP027N08B	80V, 120A, 175°C	--	--
Or	ST Microelectronics	STP270N8F7	80V, 180A, 155°C	--	--
Doide (D13、D12)	IXYS CORPORATIO N	DSEI30-06A	37A, 600V, , 155°C	--	--
Or	MICROSEMI CORPORATIO N	APT30DQ60BG	30A, 600V, , 155°C	--	--
Relay (RL1, RL2, RL3, RL4, RL5, RL6)	Xiamen Hongfa Electroacoustics Co., Ltd.	HF161F-W/12- HT	31A, 250Vac, 12Vdc, 85°C	IEC/EN 61810-1	VDE 40031410
Or	ALFG2PF121	33A,277VAC,12 VDC, Max.85°C	Panasonic Corporation	VDE 0435	VDE 40023067
Optocoupler (U14,U15,U16,U 17,U19,U20)	Liteon optoelectronics	LTV816	Di≥0.4mm, Internall di ≥ 7.0mm, External di ≥ 7.62mm, AC 8000V, 115°C	IEC 60747-5-5	VDE 40015248



14 TABLE: list of critical components					P
Component	Manufacturer/ trademark	Type/model	Value / rating	Standard	Approval/ Reference
Optocoupler U2,U3,U13,U14, U17,U18,U26,U 27,U31,U32	TOSHIBA Semiconductor Corporation	TLP350 (D4- TP1.F)	Di ≥ 0.4mm Internal di ≥ 7.0mm External di ≥ 7.0mm, AC 5000V, reinforced Insulation 100°C	DIN EN 60747- 5-2	VDE 40009302
Or	TOSHIBA	TLP352(TP1,F)	Di ≥ 0.4mm Internal di ≥ 7.0mm External di ≥ 7.0mm, 125°C	DIN EN 60747- 5-2	VDE 40009302
GFCI (L10)	Huizhou Baohui Electronics Technology Co., Ltd	W539	Class B	--	--
-Epoxy	DONGGUAN EATTO ELECTRONIC MATERIAL CO LTD	3300A-1/B-1	V-0, 130°C	UL 746 UL94	UL E218090
Or	HUI ZHOU QIANG DA ELECTRONICS INDUSTRY CO LTD	QDJ600(#)	V-0, 130°C	UL 746 UL94	UL E351561
-Tape	SHENZHEN WOER HEAT- SHRINKABLE MATERIAL CO LTD	WF	200°C	UL224	UL 203950

1) an asterisk indicates a mark which assures the agreed level of surveillance



Appendix 1

4.8.2	TABLE: Array insulation resistance detection for inverters for ungrounded and functionally grounded arrays			P
4.8.2.1	Array insulation resistance detection for inverters for ungrounded arrays			P
DC Voltage below minimum operating voltage (V)	DC Voltage for inverter begin operation (V)	Resistance between ground and PV input terminal (Ω)	Required Insulation resistance $R = (V_{MAX PV} / 30mA)$ (Ω)	Result
DC+				
100	120	21K	20K	The PV inverter cannot start-up. Error message: "PV Isolation Low"
100	340	21K	20K	
100	440	21K	20K	
100	600	21K	20K	
DC-				
100	120	21K	20K	The PV inverter cannot start-up. Error message: "PV Isolation Low"
100	340	21K	20K	
100	440	21K	20K	
100	600	21K	20K	



Appendix 2

4.8.3.5 Protection by residual current monitoring		P
Test conditions:	Output power: 100% V_{DC} : 500V Frequency: 50Hz Current measuring devices: min. class 0,5 Time measuring devices: <10% of the measured value	

+ PV to N:	
Fault Current (mA)	
Limit (mA)	U_N
≤300	245
≤300	242
≤300	243
≤300	245
≤300	243
- PV to N:	
Fault Current (mA)	
Limit (mA)	U_N
≤300	246
≤300	247
≤300	246
≤300	245
≤300	246

Note:
Fault current will rise up to 300mA within 30s. 5 values will be measured and listed.

Test for correct disconnection in case of an abrupt appearing residual current >300mA		P
+ PV to N:		
Fault Current > 300mA		
Limit (ms)	U_N	
300	262	
- PV to N:		
Fault Current > 300mA		
Limit (ms)	U_N	
300	212	

Note:
To test the trip time, the test resistance is then adjusted to set the residual current to a value approximately 10 mA below the actual trip level. A second external resistance, adjusted to cause approximately 20 mA of residual current to flow, is connected through a switch from ground to the same PV input terminal as the first resistance. The switch is closed, increasing the residual current to a level above the trip level determined above. The time shall be measured from the moment the second resistance is connected until the moment the inverter disconnects from the mains, as determined by observing the inverter output current and measuring the time until the current drops to zero.



4.8.3.5.3 Test for detection of sudden changes in residual current		P
+PV to N		
Limit (mA)	U _N	Limit (s)
	Disconnection time (ms)	
30	217	0.3
30	202	0.3
30	201	0.3
30	216	0.3
30	218	0.3
60	106	0.15
60	104	0.15
60	113	0.15
60	108	0.15
60	112	0.15
150	34	0.04
150	37	0.04
150	28	0.04
150	34	0.04
150	34	0.04
-PV to N		
Limit (mA)	U _N	Limit (s)
	Disconnection time (ms)	
30	197	0.3
30	194	0.3
30	263	0.3
30	206	0.3
30	203	0.3
60	117	0.15
60	115	0.15
60	108	0.15
60	105	0.15
60	102	0.15
150	27	0.04
150	26	0.04
150	29	0.04
150	28	0.04
150	31	0.04
Note: The capacitive current is risen until disconnection. Test condition: $I_c + 30/60/150\text{mA} \leq I_{c\text{max}}$. R ₁ is set that 30/6+0/150ma Flow and switch is closed.		



Enclosure front view



Enclosure rear view





**BUREAU
VERITAS**

Test Report No: LD190808N030

Enclosure front and side view



Enclosure rear and side view

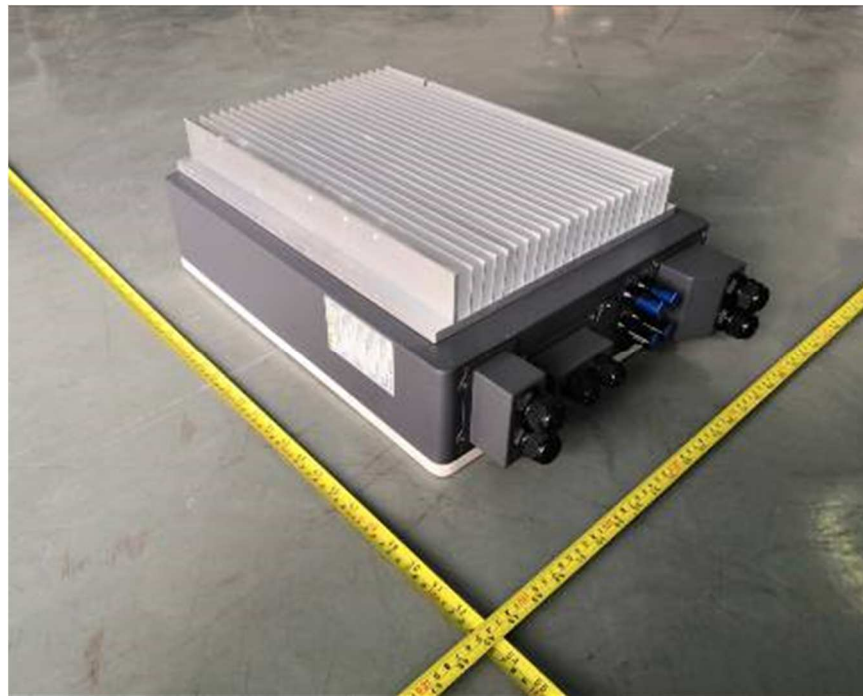



**BUREAU
VERITAS**

Test Report No: LD190808N030

Enclosure Bottom view



Internal view: HYD 6000-ES, HYD 5000-ES, HYD 4600-ES





Internal view: HYD 4000-ES, HYD 3600-ES, HYD 3000-ES

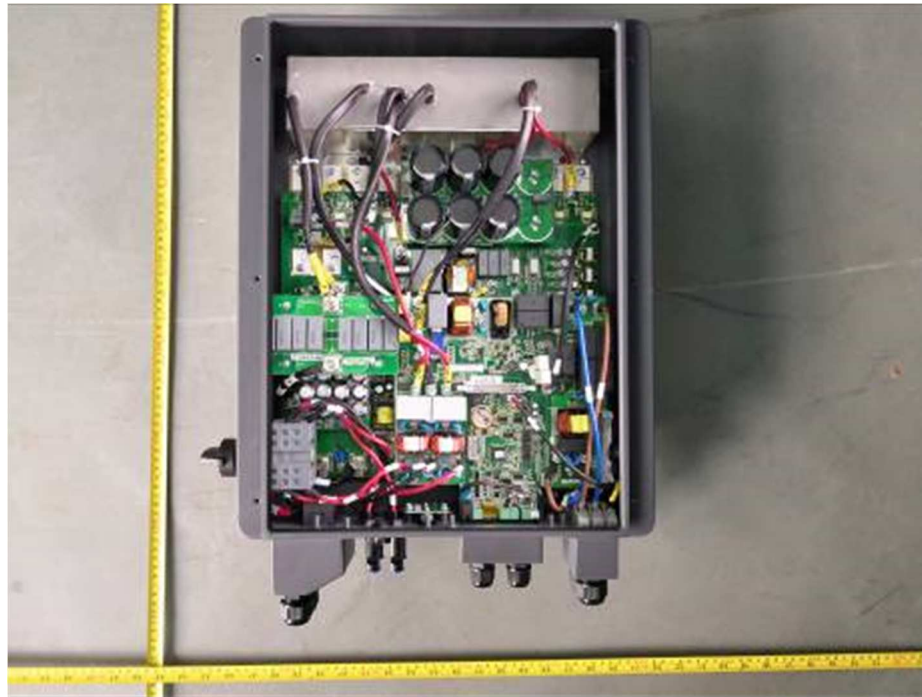

Internal view-1

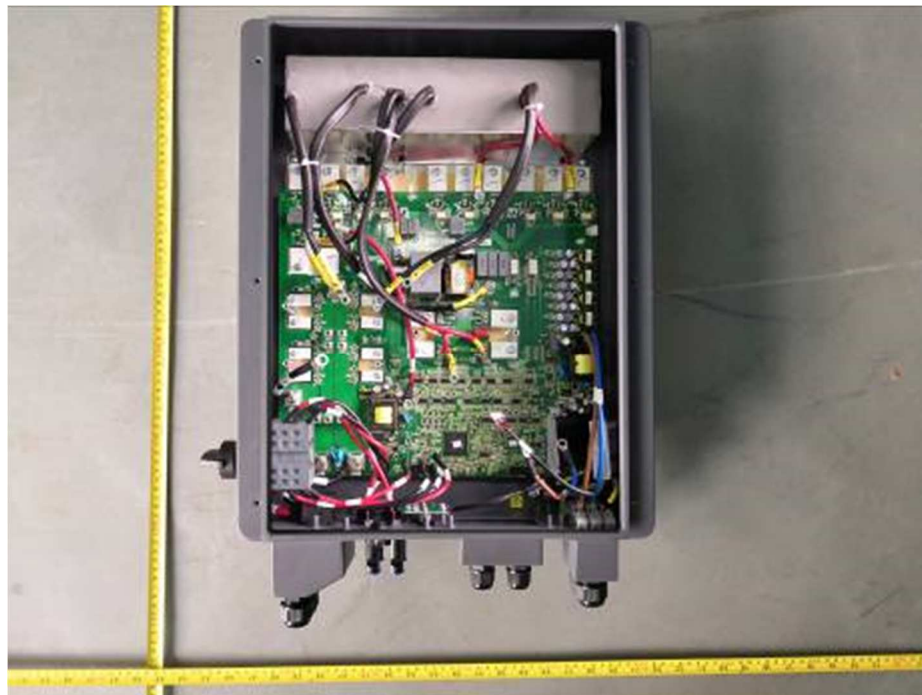



**BUREAU
VERITAS**

Test Report No: LD190808N030

Internal view-2

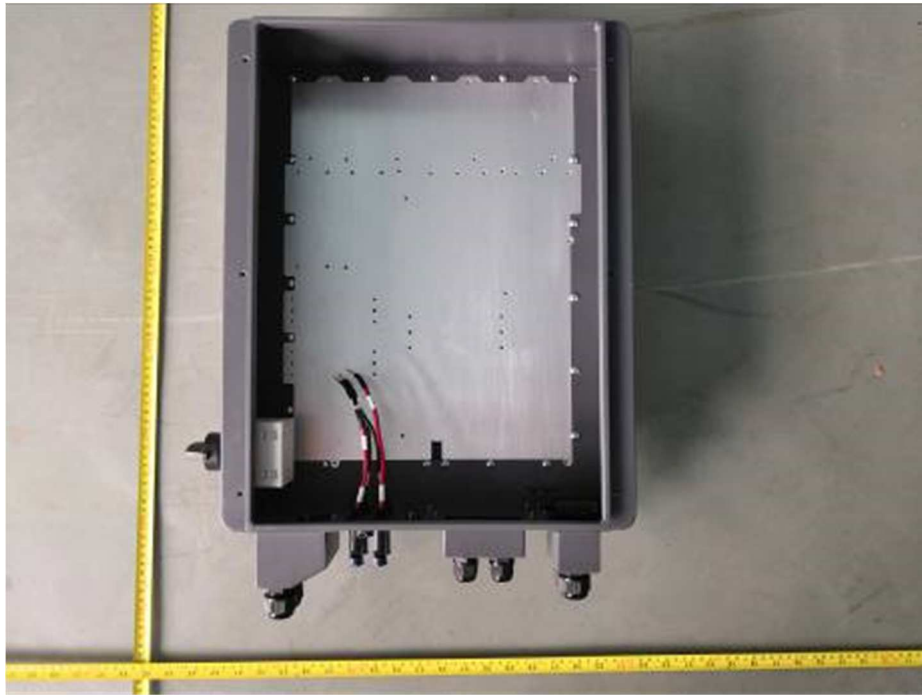

Internal view: Ground terminal





Main power board component side view

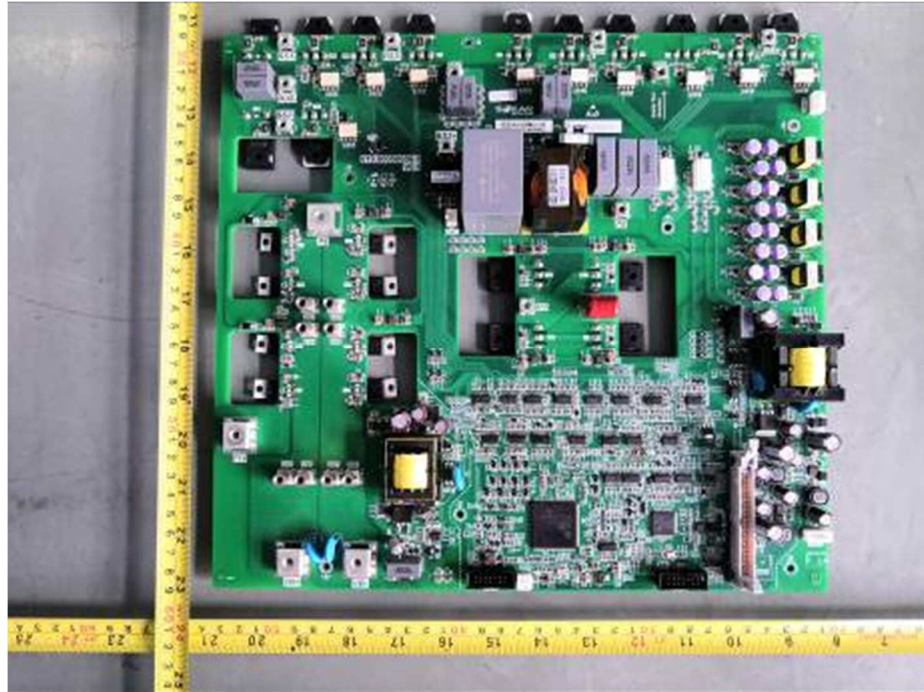

Main power board solder side view

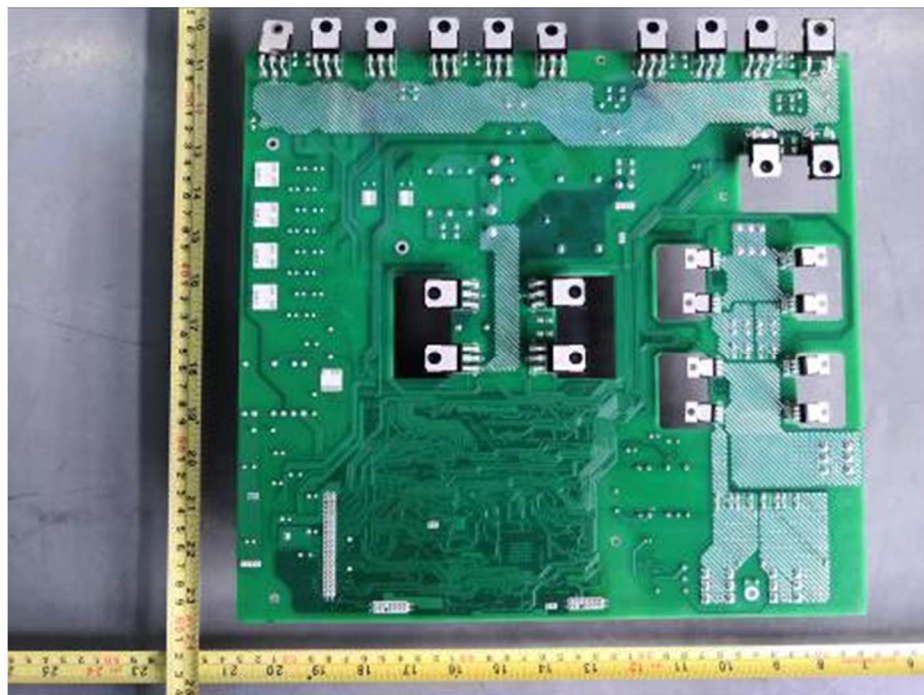



Input&output board component side view

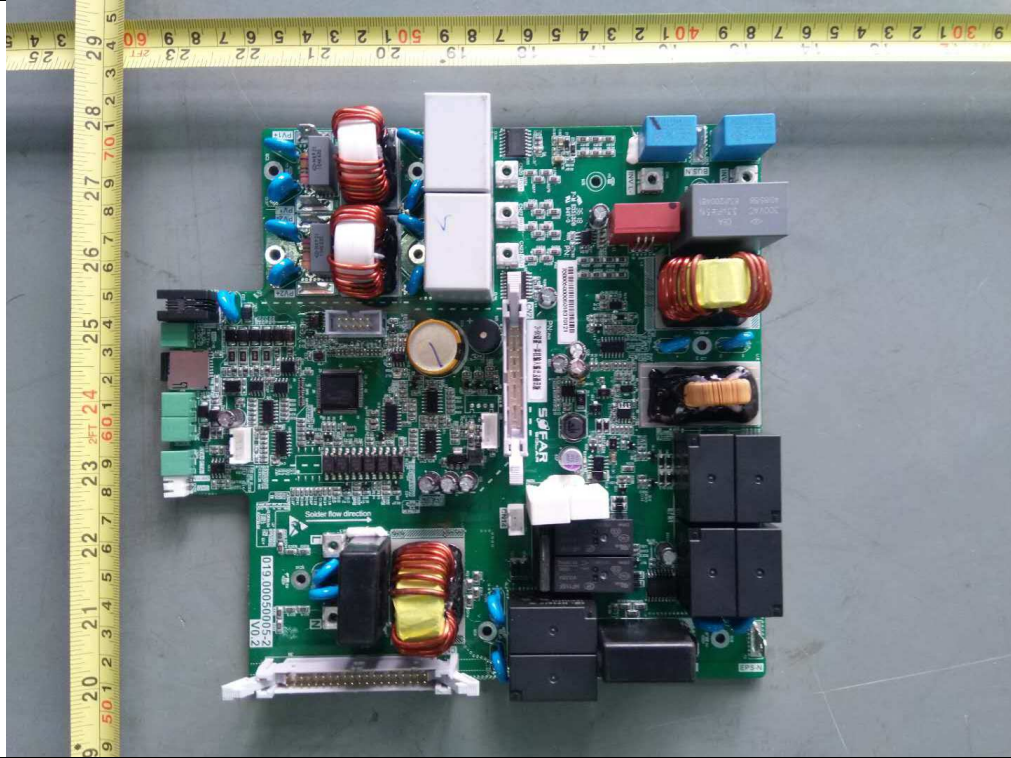

Input&output board solder side view

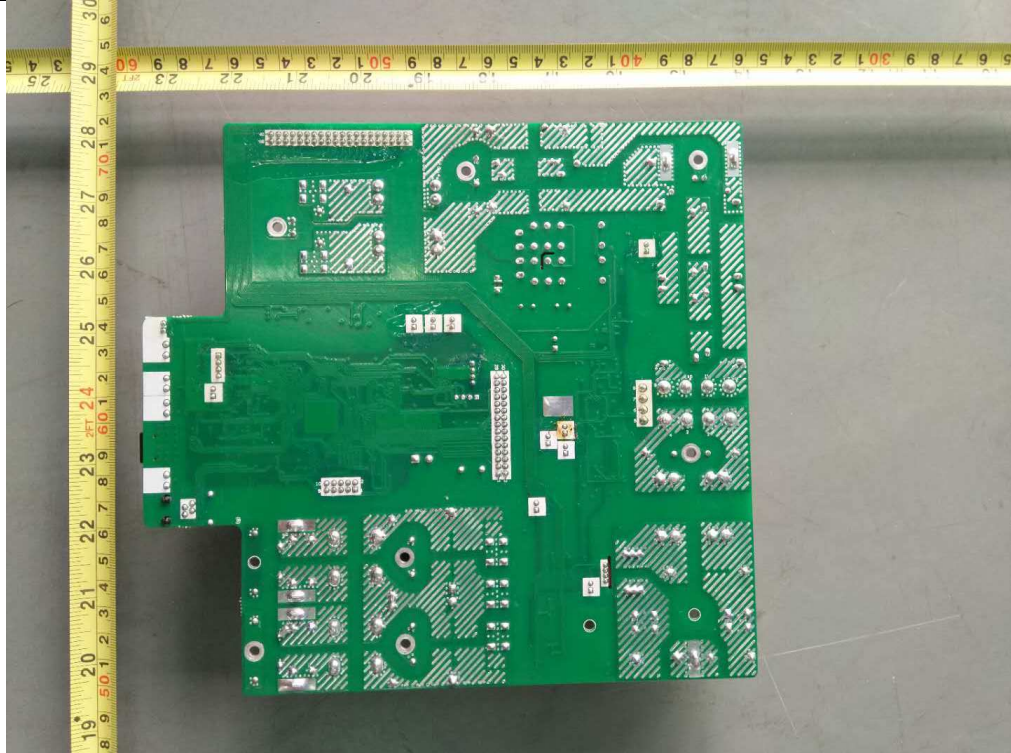



Capcittance board component side view: HYD 6000-ES, HYD 5000-ES, HYD 4600-ES

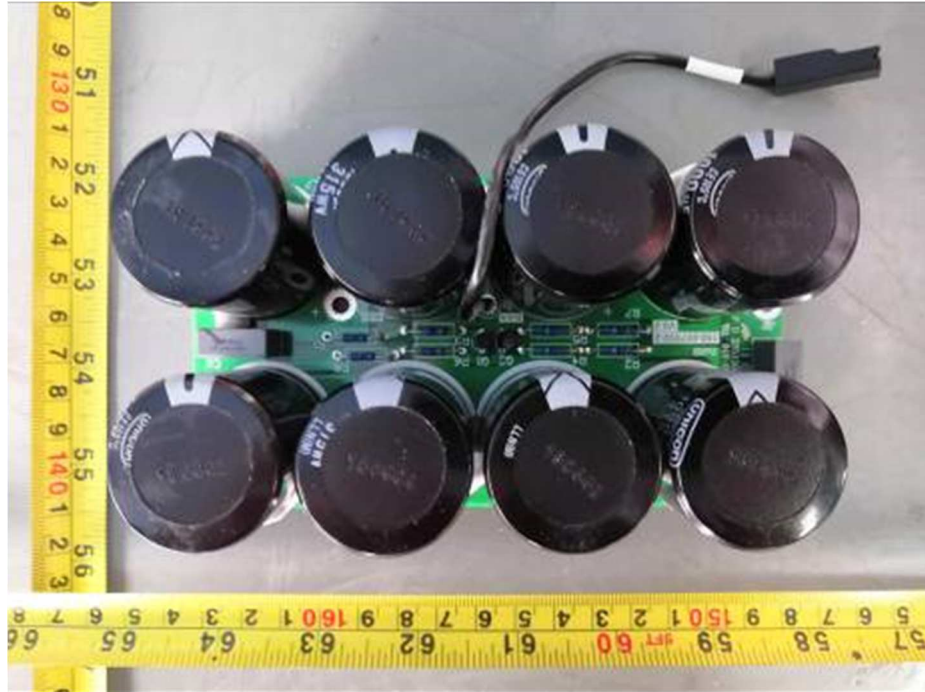

Capcittance board solder side view: HYD 6000-ES, HYD 5000-ES, HYD 4600-ES

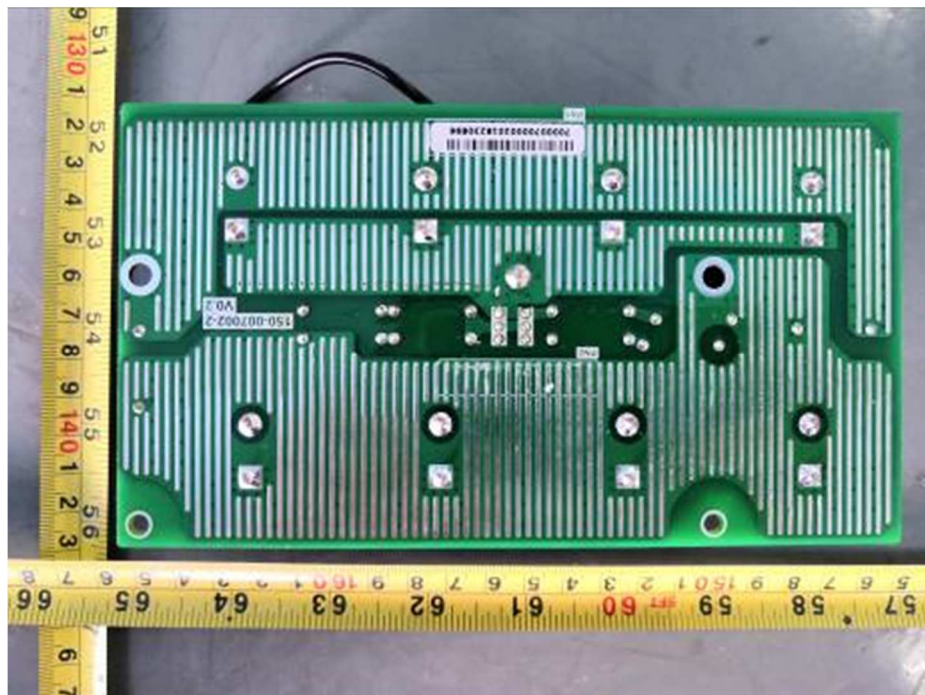



Capcittance board component side view: HYD 4000-ES, HYD 3600-ES, HYD 3000-ES

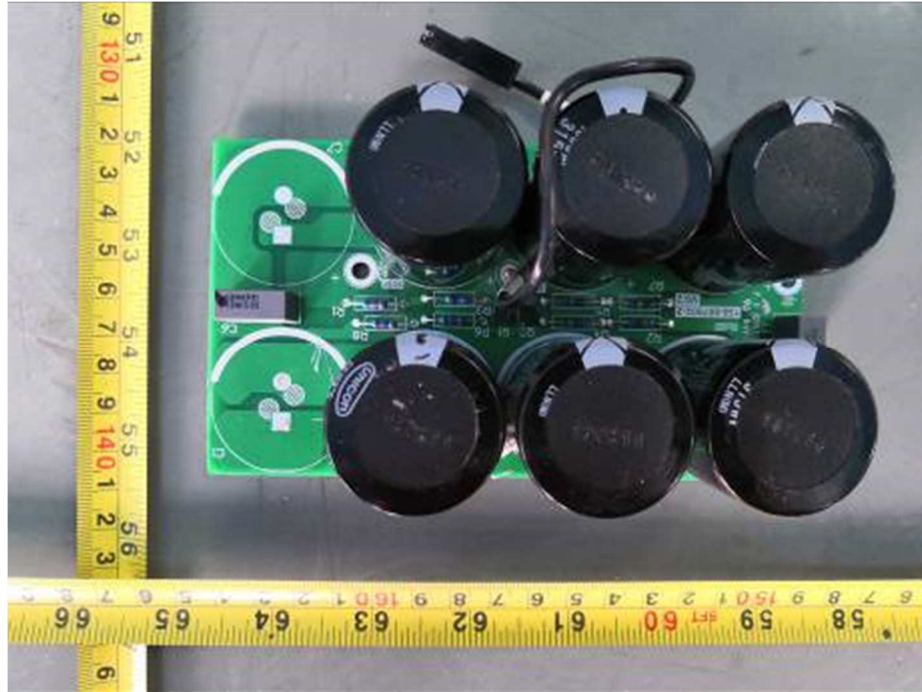

Capcittance board solder side view: HYD 4000-ES, HYD 3600-ES, HYD 3000-ES

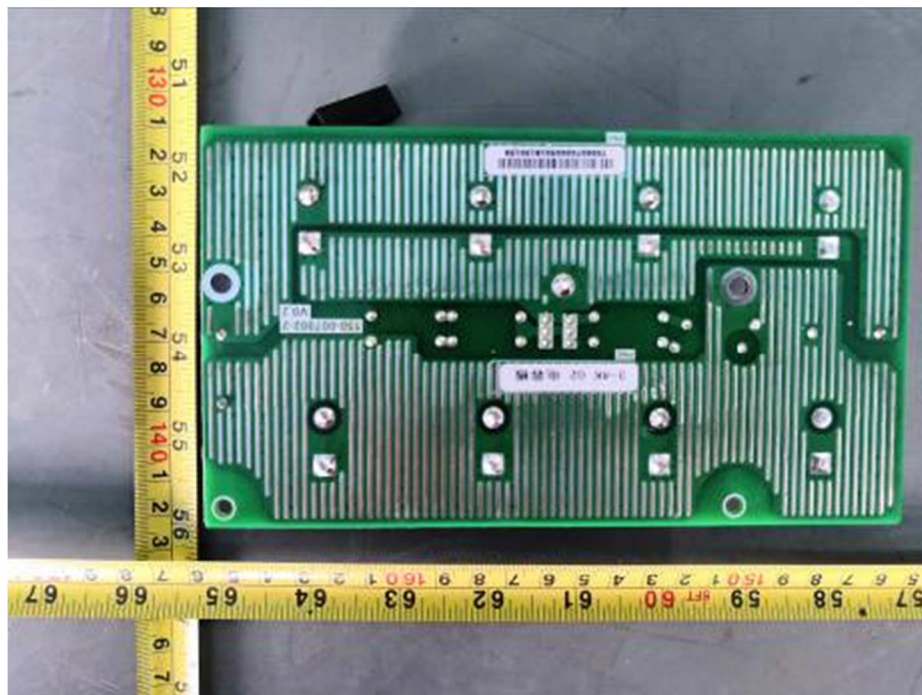



Capciance B board component side view



Capciance B board solder side view

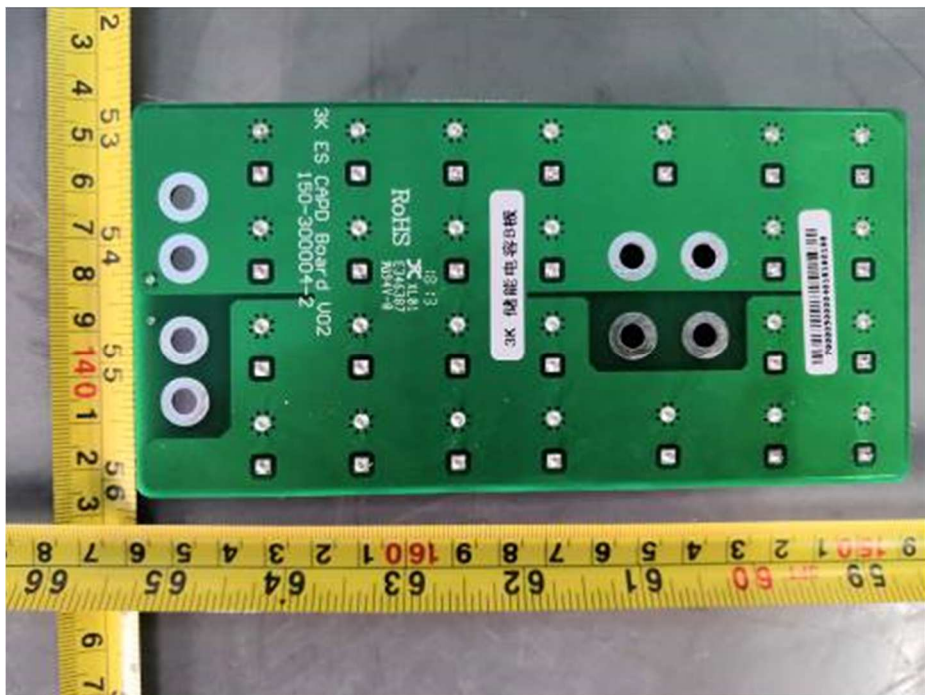



Capcintance A board component side view

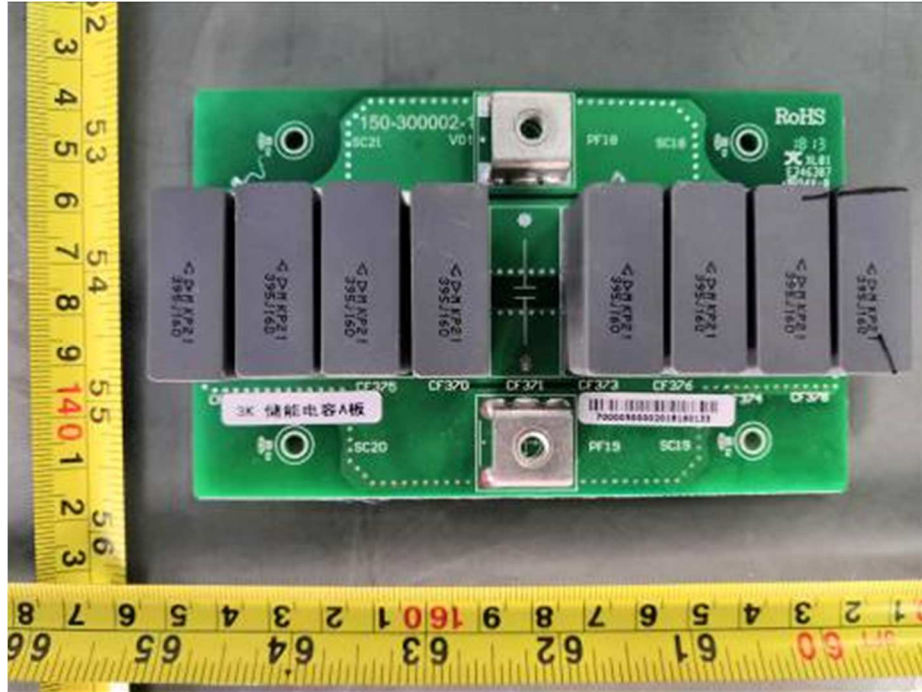

Capcintance A board solder side view

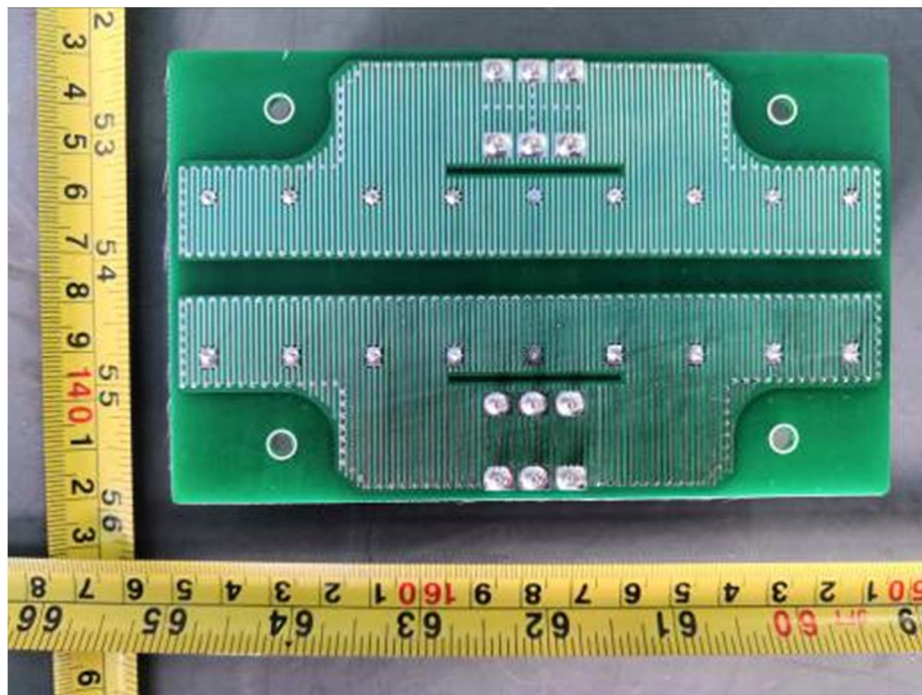



LCD board component side view



LCD board solder side view

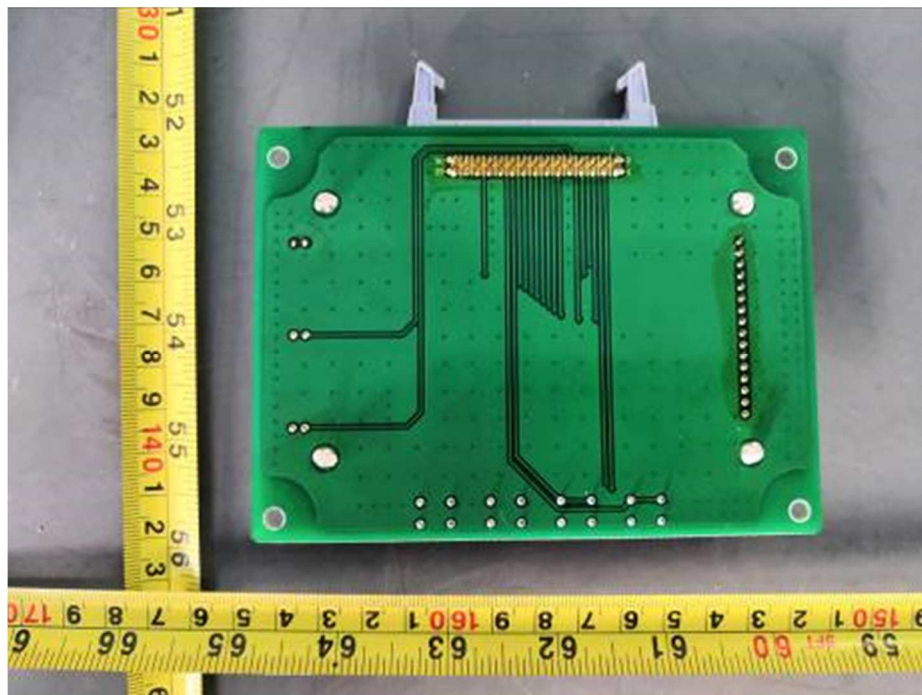



RS232 board component side view



RS232 board solder side view

